

**Healthy and Affordable Housing:
Practical Recommendations
for Building, Renovating
and Maintaining Housing**

**READ
THIS**

**BEFORE YOU DESIGN,
BUILD OR RENOVATE**



**READ
THIS**

BEFORE YOU DESIGN, BUILD OR RENOVATE

FOREWORD

This pamphlet offers guidance about residential building and remodeling practices that foster healthy homes by reducing the housing occupants' risk of exposure to known hazards. These practices also frequently yield other benefits such as improved durability and reduced operating costs.

It is designed for members of the residential building construction and remodeling industries, as well as owners and managers who work in affordable housing. It presents building guidance for both new construction and rehabilitation, as well as practices that can be used by property maintenance personnel.

TABLE OF CONTENTS

The Building Connection	6
Housing and Health	
Before You Design, Build or Renovate	
Systems Approach	
The Seven Steps to a Healthy Home	
Factors That Must be Controlled For a Healthy Home	
Recommendations	9
Water	9
Rainwater Control	
Groundwater	
Plumbing	
Drying	
Air	27
Big Holes - Building Boundaries	
Cold Surfaces	
Indoor Humidity and Airborne Pollutants	
Pressures	
Combustion	43
Combustion Appliances	
Garages	
Smoke	
Dust	45
Entry Control	
Cleanable Surfaces	
Filtration	
Creatures	46
Keeping Them Out	
Reducing Food and Water	
Pesticides	
Appendix	48
Sample Healthy Homes Building Guidance for New Construction	
and Rehabilitation	

ACKNOWLEDGMENTS

This document was prepared by Joseph Lstiburek and Terry Brennan. The illustrations and layout were done by Stephanie Finegan. The document was significantly enhanced by the thoughtful review of the following individuals:

Marty Nee, U.S. Department of Housing and Urban Development	Naomi Mermin, Tufts University
Ellen Tohn, ERT Associates	Eric Oetjen, ICF Consulting
David Jacobs, Ph.D., U.S. Department of Housing and Urban Development	John Snell, Peregrine Energy
Ellen Taylor, U.S. Department of Housing and Urban Development	David Grimsrud, Ph.D., Grimsrud & Associates
Lisa Humble, AIA, State of Connecticut	Nathan Yost, MD, Building Science Corporation
Kate Bennett, Boston Housing Authority	Betsy Pettit, AIA, Building Science Corporation
Linda Wigington, Affordable Comfort, Inc.	Hap Haven, Energy Coordinating Agency, Philadelphia, PA
Helen Perrine, Affordable Comfort, Inc.	Erin Hamernyik, Opportunity Council, Bellingham, WA
Steve Bostwick, Bostwick Forensic Architecture, Wyoming, OH	Paul Knight, Domus PLUS, Oak Park, IL
Bruce Davis, Advanced Energy Corporation, Raleigh, NC	Jim LaRue, The HouseMender, Inc., Cleveland, OH
John Davies, The Building Performance Center, Bellingham, WA	Dennis Livingston, Community Resources, Baltimore, MD
Stephen C. Frantz, NYS Dept. of Health, Albany, NY	Barbara Miller, National Affordable Housing Network, Butte, MT
Don Fugler, Canada Mortgage & Housing Corp., Ottawa, Ontario, Canada	Gary Nelson, The Energy Conservatory, Minneapolis, MN
Gloria Fultz, Affordable Comfort, Inc.	Eric Werling, ICF Consulting, Purcellville, VA
Jeff Gordon, Building Research Council, Champaign, IL	Dennis Creech, Southface Energy Institute, Atlanta, GA
Bill Rose, Building Research Council, Champaign, IL	

DISCLAIMER

The contents of this pamphlet represent the opinions of the author only and are not the official views or policies of the U.S. Department of Housing and Urban Development or the U.S. Government.

FEEDBACK

The U.S. Department of Housing and Urban Development and the Building America Program at the U.S. Department of Energy welcome feedback on this document. Please send feedback to:

The Office of Healthy Homes and Lead Hazard Control, U.S. Department of Housing and Urban Development at: healthyhomes@hud.gov

and

Building Science Corporation at: feedback@buildingscience.com

and

George James for the Building America Program, U.S. Department of Energy at:

George.James@ee.doe.gov

Support for the production of this document was provided by the U.S. Department of Housing and Urban Development and the U.S. Department of Energy
Copyright ©2001-2004 Building Science Corporation

The Building Connection

Housing and Health

Asthma It is a serious disease that affects millions of Americans, particularly children, and it is increasing at an alarming rate. Asthma is an allergic reaction to certain exposures (“triggers”) such as dust, mold, pests (cockroaches, rats, mice), pets (cats and dogs), cold air, and dry heat. These conditions can trigger other allergic reactions that include hayfever symptoms like itching eyes and runny noses. Many air pollutants that are associated with asthma are found at higher levels indoors than outdoors. Among them are the most common asthma triggers: particles from molds, dust mites, mice, rats, roaches and pets.

Other Health Issues Indoor air contains other pollutants — such as carbon monoxide, volatile organic compounds (chemicals released from materials) nitrogen oxides, sulfur oxides, radon, soot and other particles — that can make people sick or make asthma worse. Some pollutants — ozone, sulfur oxides, carbon monoxide, pollens, soot — come from outside. Homes built before 1978 may contain lead-based paint, which during a renovation job can become hazardous if lead dust or paint chips are created by the work. Children or others in the home can easily ingest the dust and paint chips. The federal government has recommended work practices in the Lead Paint Safety Field Guide that help to contain and clean up lead dust and paint during and after rehabilitation work. A copy of the Lead Paint Safety Field Guide can be found at www.hud.gov/offices/lead.

Why Construction and Design Matter We can control many of the sources of pollution that otherwise can make people sick or make asthma worse by good design, construction, renovation, maintenance and operation.

What people bring into their home, how they live in their home and how they clean and maintain their home also affect the quality of the air in their home.

Before You Design, Build or Renovate

The principles for a healthy home are the same for all types of construction: rehabilitation, new construction, low rise, high-rise, single family or multifamily.

The design and construction options for rehabilitation are limited by conditions of the salvaged building and equipment and extent of the rehabilitation. Despite the limitations, the same principles apply to whatever work is done as part of the rehabilitation.

Systems Approach Can Save Money

Applying the principles for a healthy home to design, construction and renovation does not have to result in significant cost increases. By understanding the interactions between building systems we can identify cost saving trade-offs that improve building performance and improve control of interior conditions such as comfort – particularly temperature and interior humidity. Additionally, many of the principles result in reduced callbacks and warranty claims.

The whole is greater than the sum of the parts.

Cost Saving Trade-Offs

Improve Building Envelope	Costs More (+)
Downsize Mechanical System	Costs Less (-)
	<hr/>
	Cost Remains the Same

The Seven Steps to a Healthy Home

There are seven steps to a healthy home. Ideally, a healthy home is:

- Dry
- Clean
- Well Ventilated
- Combustion By-Product Free
- Pest Free
- Toxic Chemical Free
- Comfortable

Not all steps can be controlled by design, construction and renovation. How people live in a home also matters. And not all steps can be achieved perfectly or completely or practically — they are goals.

Dry

Water and humidity support the growth of mold, insects, rodents and dust mites. Keeping a home dry controls mold and pests, and discourages dust mites.

Clean

Dust provides food for mold, insects, rodents and dust mites, and in older homes may contain lead. Clutter makes it difficult to clean and in many cases it also may serve as food for pests. Keeping a home clean helps control mold and pests. Smooth and cleanable surfaces make it easier to remove dust.

Well Ventilated

Ventilation provides a mechanism to remove pollutants and control humidity. Windows that open and fans that run control pollutants.

Combustion By-Product Free

Combustion by-products —such as carbon monoxide, sulfur oxides, nitrogen oxides and soot — should not be in a healthy home. Furnaces, water heaters and fireplaces that burn fuel must vent to the outside. Stoves, ovens and cook-tops that burn fuel must be used with fans that vent the combustion by-products to the outside.

Pest Free

Pests can lead to allergic reactions and to the use of pesticides. Food and water attract pests. Controlling food and water helps to minimize pests.

Toxic Chemical Free

We are surrounded by chemicals, no environment can be made completely chemical free. But we can control our exposure. Many things found in houses can be toxic in large doses. Some we can control by design and construction such as selecting materials that don't smell or release chemicals. Others we can control by the way we live in the home. For example, many cleaning compounds, pesticides, oil or alkyd based paints and solvents can lead to problems. Many of the containers that these products are stored in slowly release the chemicals. It is best not to store these products inside. When in doubt, safely dispose of these products. Many municipalities operate household chemical disposal programs.

Comfortable

Uncomfortable homes can make people take action that makes a home unhealthy. Too hot or too cold is usually uncomfortable.

Operable windows can control heat and provide ventilation. But sometimes when it is too cold windows will not be opened, and sometimes when it is too hot even opening windows will not cool the home enough.

And what happens when people are scared to open windows?

Sometimes the outside air has pollutants such as ozone and pollen that may require some people to keep windows closed and filter incoming air.

If people are cold they won't ventilate their home. If people can't afford to heat their home they won't ventilate their home.

A healthy home has windows that open and fans that run – but a healthy home must also be healthy when windows are closed because it is too cold, because it is too hot, because people feel unsafe or because pollutants are present in the outside air.

Uncomfortable can also be too dry or too humid.

When a home is uncomfortably dry, people often humidify. Many times when people humidify they can over-humidify. Over humidifying may result in mold and mites and other pests. A properly built or renovated home will not require a humidifier to be comfortable.

When a home is uncomfortably humid, particularly in the summer and fall, it may require a dehumidifier or air conditioner. Even properly built or renovated homes may require a dehumidifier or air conditioner to control humidity in the summer and fall to be comfortable and healthy — particularly in the southeast.

Factors That Must be Controlled for a Healthy Home

In order to address the seven steps to a healthy home the design, construction and renovation must control the following factors:

Water

- Rainwater Control
- Groundwater
- Plumbing

Dust

- Entry Control
- Lead Dust Control
- Cleanable Surfaces
- Filtration

Air

- Big Holes - Building Boundaries
- Cold Surfaces
- Indoor Humidity
- Airborne Pollutants
- Pressures

Creatures

- Keeping Them Out
- Reducing Food and Water

Combustion

- Combustion Appliances
- Garages
- Smoke

Recommendations

Water

Water is a precondition for mold, insects, rodents, dust mites and is arguably the single most important factor in the design and construction of a healthy home. Water is the most important factor affecting the durability of a home and the most important factor affecting maintenance costs.

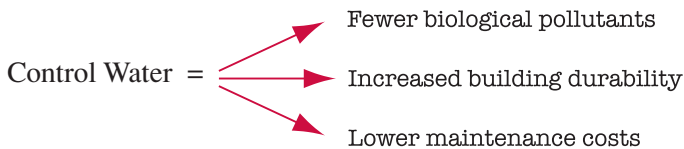

The three most important sources of water requiring control are:

- Rainwater Control
- Groundwater
- Plumbing

One of the key elements of water control is the concept of drying. It is common sense to accept that things will get wet. Especially homes. Especially homes under construction or under renovation. All homes will get wet.

The problem is not that something gets wet. It's how long it stays wet and how well it dries. Homes should be designed to dry.

Rainwater Control

The fundamental principle of rainwater control is to shed water by layering materials in such a way that water is directed downwards and outwards from the building or away from the building. It applies to assemblies such as walls, roofs and foundations, as well as to the components that can be found in walls, roofs and foundations such as windows, doors and skylights. It also applies to assemblies that connect to walls, roofs and foundations such as balconies, decks, railings and dormers.

Layering materials to shed water applies to the building as a whole (see **Figure 1**). Overhangs can be used to keep water away from walls. Canopies can be used to keep water away from windows, and site grading can be used to keep water away from foundation perimeters.

When selecting building materials, take into account that building materials may be exposed to rain or other elements during construction. For example, walls without roofs on them will get wet. It is not a good idea to build these walls with exterior gypsum board that is paper-faced since they hold water. This is a major concern with party walls or fire walls in multifamily buildings. Glass-faced gypsum board or other water-resistant alternatives should be used.

Drainage is the key to rainwater control:

- Drain the site (see **Figure 1**)
- Drain the ground
- Drain the building (see **Figure 2**)
- Drain the assembly
- Drain the opening (see **Figure 3**)
- Drain the component
- Drain the material (see **Figure 4**)

Walls All exterior claddings pass some rainwater. Siding leaks, brick leaks, stucco leaks, stone leaks, etc. As such, some control of this penetrating rainwater is required. In most walls, this penetrating rainwater is controlled by a drainage plane that directs the penetrating rainwater downwards and outwards.

Drainage planes are water repellent materials (building paper, house wrap, foam insulation, etc.), which are located behind the cladding and are designed and constructed to drain water that passes through the cladding. They are interconnected with flashings, window and door openings, and other penetrations of the building enclosure to provide drainage of water to the exterior of the building. The materials that form the drainage plane overlap each other shingle fashion or are sealed so that water drains down and out of the wall.

Reservoirs on the outside of homes are a problem. What are reservoirs? Materials that store rainwater – sponges that get wet when it rains. Once the reservoirs get wet, the stored water can migrate elsewhere and cause problems (see **Figure 5**). Common reservoirs are brick veneers, stuccos, wood siding, wood trim and fiber cement cladding.

How to handle reservoirs? Easy. Get rid of them or disconnect them from the building (see **Figure 6**). Back priming (painting all surfaces, back, front, edges and ends of wood siding, cement siding and all wood trim) gets rid of the moisture storage issue with these materials. No reservoir, no problem.

Back venting brick veneers and installing them over foam sheathings disconnects the brick veneer moisture reservoir from the home (see **Figure 7**). Installing stucco over two layers of building paper or over an appropriate capillary break, such as foam sheathing, similarly addresses stucco reservoirs.

Roofs Roofs should be designed to shed rainwater away from the building. Steep pitches are better than shallow pitches. Crickets should be used to divert water away from chimneys and architectural features.

Roofs should also be designed to protect walls. Large overhangs are better than small overhangs or no overhangs.

Ideally, roofs should have simple geometry. The more complex the roof, the more dormers, ridges and valleys, the more likely a roof will leak. Penetrations should also be minimized or avoided.

Figure 1
Layering materials to shed water applies to whole building

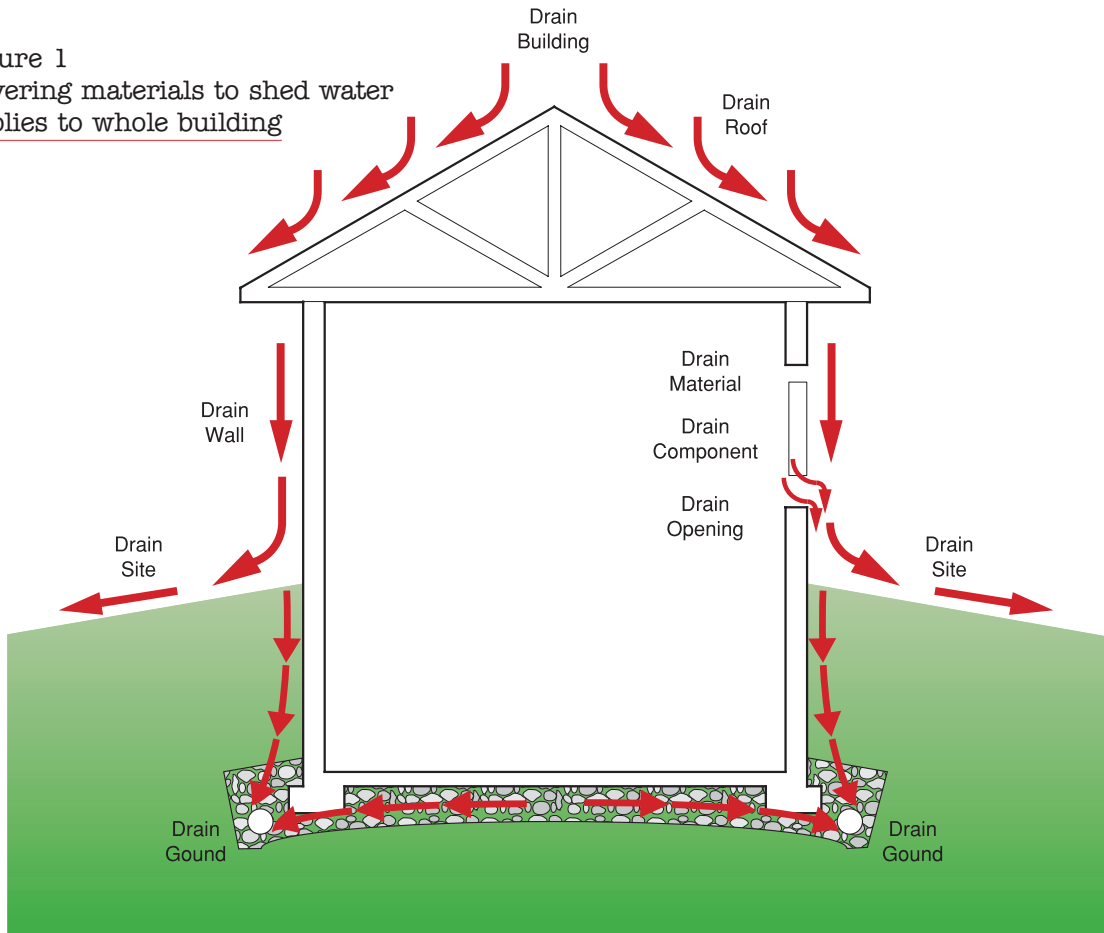

Figure 2
Drain the building

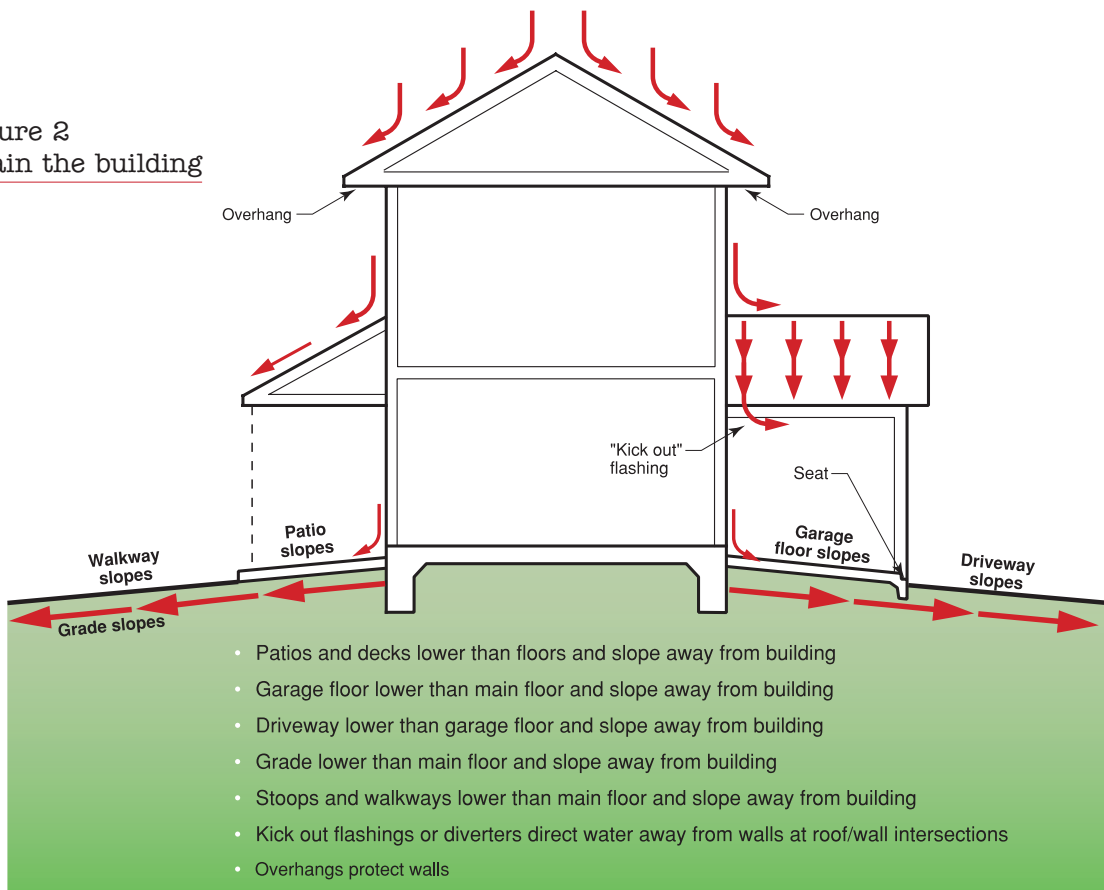
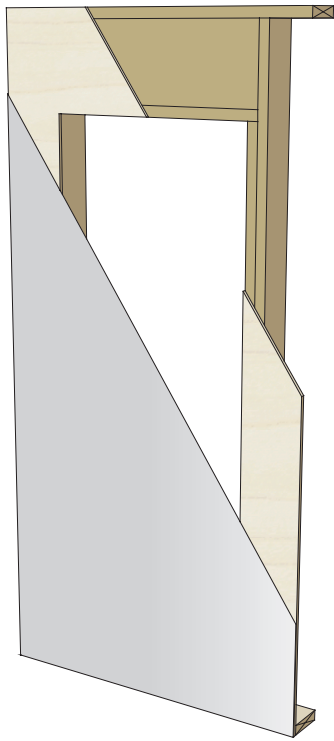
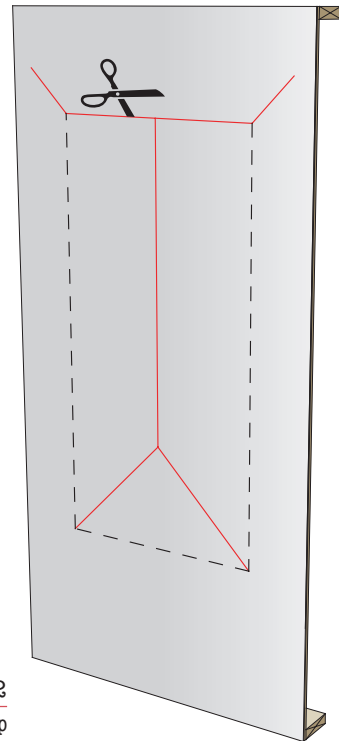

Figure 3
Installing window with housewrap on OSB over a wood frame wall



Step 1

- Wood frame wall with OSB and housewrap



Step 2

Modified "I" cut in housewrap

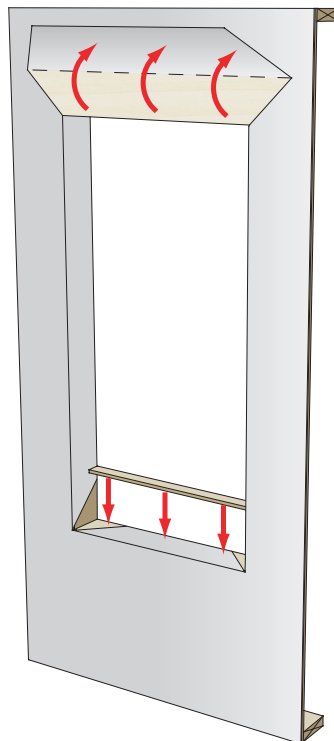

Step 3

- Housewrap folded in; alternately, tuck head flap under
- Install wood backdam

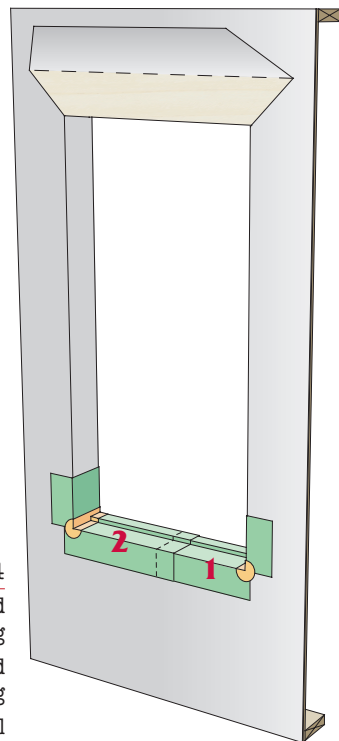

Step 4

- Install first piece of adhesive-backed flashing
- Install second piece of adhesive-backed sill flashing
- Install corner flashing patches at sill

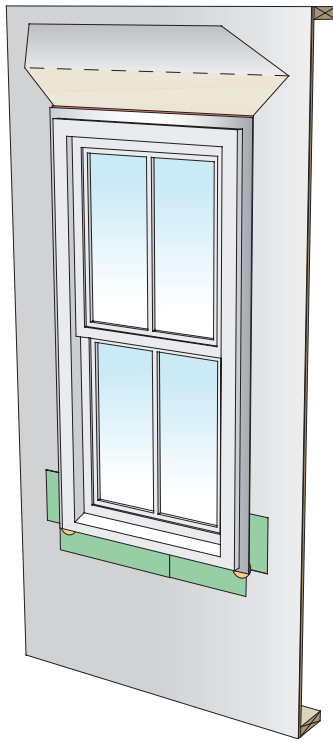

Step 5
Install window

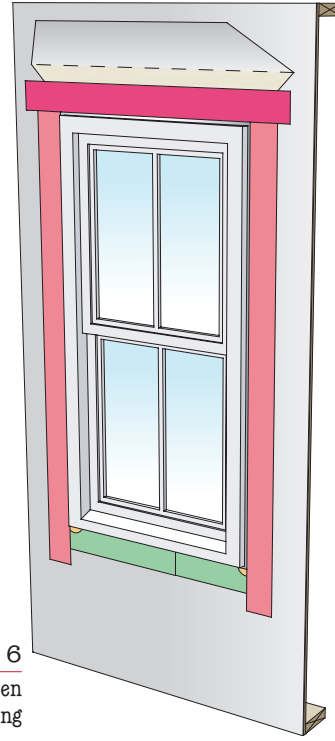

Step 6
Install jamb flashing first then
head flashing

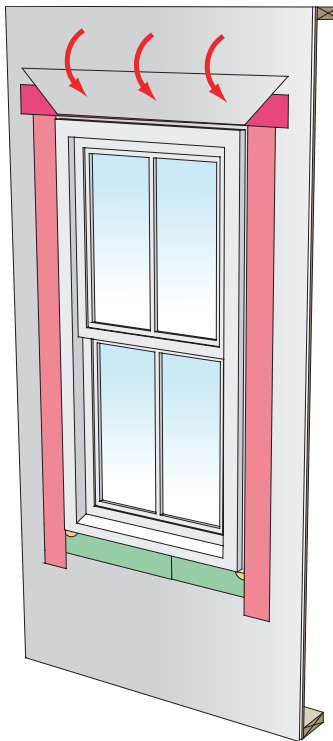

Step 7
Fold down head housewrap

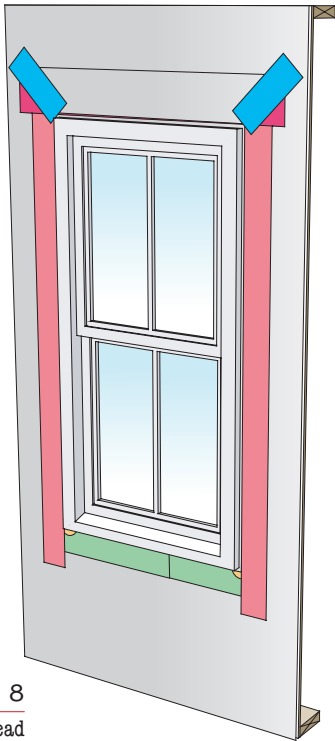

Step 8
Apply corner patches at head

Figure 4
Flashing over and under window trim

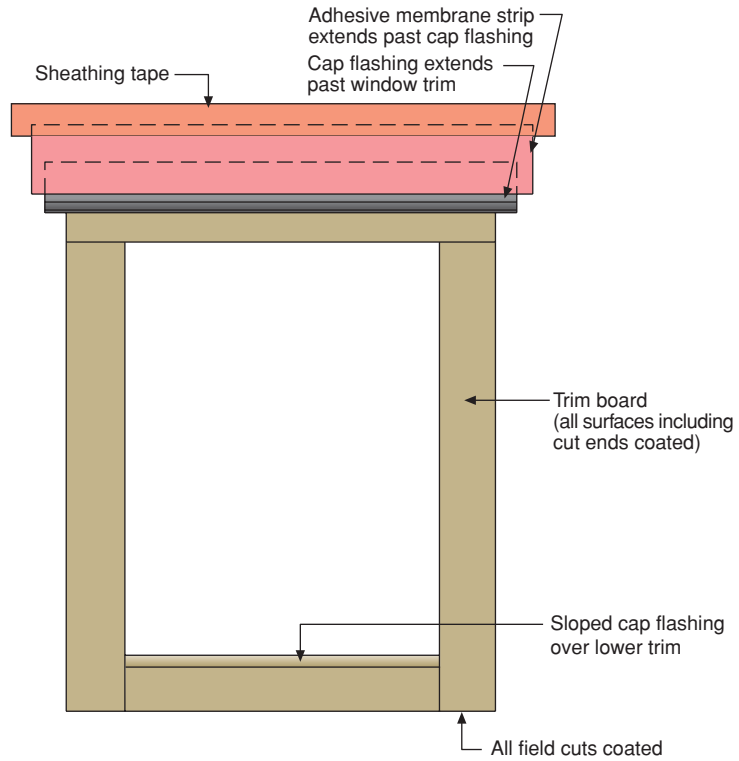
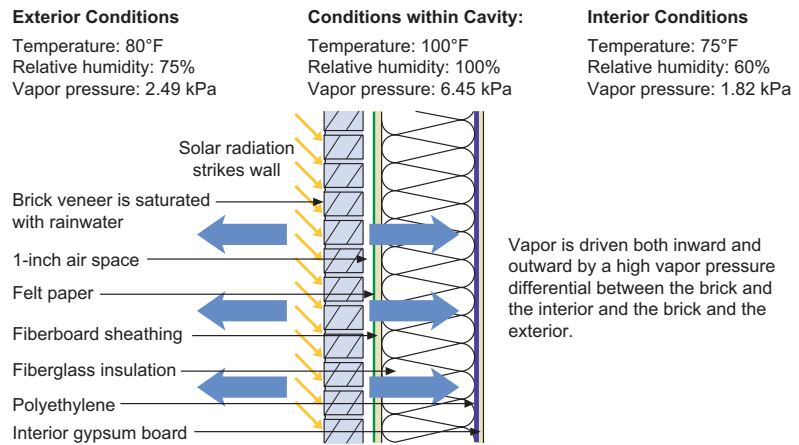
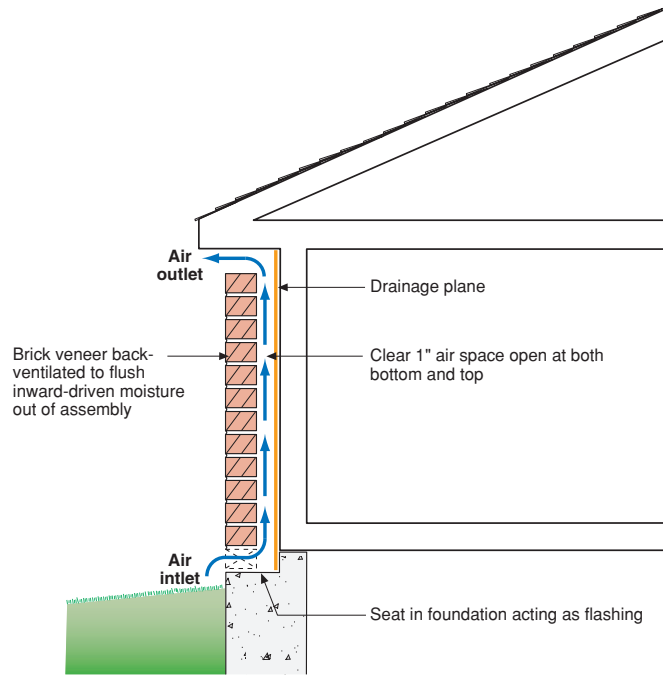

Figure 5
Problems with interior polyethylene:
Inward moisture movement due to solar radiation



- It is not a good idea to install a vapor barrier (polyethylene) on the inside of an air conditioned assembly. Vinyl wall coverings and foil-backed batt cavity insulation should also be avoided.
- Vapor permeable exterior sheathings, housewraps or building papers should not be used with absorptive claddings such as brick veneers unless a ventilated cavity is provided in conjunction with high inward drying potentials (i.e. no interior polyethylene vapor barriers).
- Failure will occur when brick is installed over a frame wall constructed with felt paper, fiberboard sheathing and an interior polyethylene vapor barrier. Kraft-faced fiberglass batts should be used in place of unfaced batts and a polyethylene vapor barrier. OSB, plywood or foam sheathing should be used in place of the fiberboard sheathing.
- Similar problems occur with stucco.

Figure 6
Ventilated cavity



- To effectively uncouple a brick veneer from a wall system by using back ventilation, a clear cavity must be provided along with both air inlets at the bottom and air outlets at the top

Figure 7
Drained cavity with condensing surface

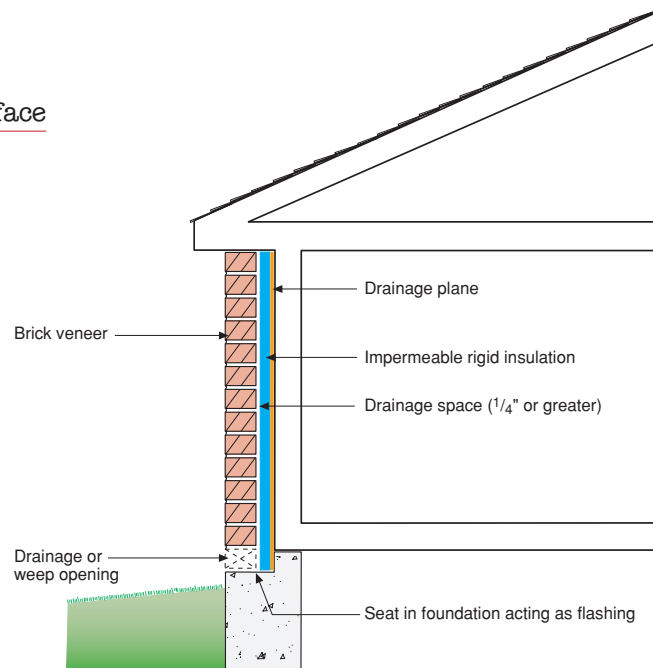

- To effectively uncouple a brick veneer from a wall system by using a condensing surface, the drainage plane must also be a vapor barrier or a vapor impermeable layer (i.e. rigid insulation) must be installed between the drainage plane and the brick veneer. Alternatively, the rigid insulation can be configured to act as both the drainage plane and vapor impermeable layer.
- When a condensing surface is used to uncouple a brick veneer from a wall system, a ventilated air space is no longer necessary — i.e. the presence of mortar droppings is no longer an issue. Additionally, the width of the drainage space is almost irrelevant.

Groundwater

The fundamental principles of groundwater control are to keep rainwater away from the foundation wall perimeter and to drain groundwater with sub-grade perimeter drains before it gets to the foundation wall. This applies to slabs, crawlspaces and basements (see **Figures 8a, 8b** and **8c**) regardless of whether they are newly constructed or undergoing rehabilitation (see **Figure 9**).

Capillary Breaks Concrete and masonry are sponges – they can absorb or “wick” water due to capillarity (see **Figure 10**). This is the main reason that damp proofing (the black tar-like coating) is applied to exterior basement walls. The damp proofing fills in the pores in the concrete and masonry to reduce ground water absorption. The damp proofing is a capillary break. Under concrete floor slabs, the stone layer combined with polyethylene serves a similar function (they act as capillary breaks). Unfortunately, the capillary rise through footings is typically ignored. This can be a major problem if foundation perimeter wall are finished or insulated.

In new construction a capillary break should be installed on the top of the footing between the footing and the perimeter foundation wall (see **Figure 11**). This can be done by dampproofing the top of the footing or by installing a membrane at this location.

Interior Basement Insulation In new construction, and particularly in renovations, the interior insulation and finishing approach must take into account the moisture migrating up through the footing. This is best accomplished by installing vapor semi-permeable rigid foam insulation on the interior of the assembly to protect the interior finishes and to release the capillary water to the interior in a controlled manner— at a rate that does not damage interior finishes or lead to mold.

The best foams to use have a perm rating of greater than 1 perm for the thickness used. This means limiting extruded polystyrene insulation to less than 1-inch thickness for walls (when they are more than 1-inch thick they do not breathe sufficiently) and making sure that the rigid insulation is not faced with polypropylene skins or foil facings. Additionally, since foams need to be protected from fire, and this is often done with gypsum board, only latex paint should be used on interior gypsum finishes (since latex breathes). This breathability requirement for rigid foams limits the thickness and therefore the thermal resistance of the wall. If higher insulation levels are required, an interior insulated frame wall can be added (see **Figure 20**).

Slab-on-Grade Construction Capillary control also applies to slab-on-grade construction and crawlspaces (see **Figure 12**). Monolithic slabs need plastic ground covers that extend under the perimeter grade beam and upwards to grade. Additionally, the exposed portion of the slab edge that is exposed to the outside must be painted with latex paint to reduce water absorption and a capillary break must be installed under perimeter wall framing.

Interior perimeter drainage can also be used in new construction — particularly where impermeable rigid insulation is used on the interior of the foundation wall. This allows rigid insulation of greater than 1-inch to be used. And, if foil-faced rigid insulation is used — with the appropriate flame-spread and smoke-developed rating — it can be left exposed (i.e. interior gypsum board does not have to be installed as thermal barrier for fire protection. See **Figure 14**).

Also in renovations, the conditions under a slab may be difficult to determine, or once they are determined, it is found that a stone layer or polyethylene is not present. It may be necessary to provide “top side” control of water and vapor. This can be done several ways. If salts are not present in the ground, epoxy coatings or chemical sealers may be used. Salts lead to osmosis and osmotic pressures are typically greater than the bond strength of most coatings and sometimes exceed the cohesive strength of concrete (i.e. the coating is pushed off the slab or the concrete

spalls/flakes apart). If salts are present, spacer systems that provide vapor control and drainage can be used over the top of existing slabs (see **Figure 16**).

A “floating floor” (see **Figure 15**) can also be used where moisture flow upwards is small – or where a finished wood floor (or carpet) is to be installed over a slab. Rigid insulation and plywood are installed on the top of the slab. In this assembly extruded polystyrene should be limited to $\frac{3}{4}$ - inch or less so that the slab can dry upwards (floors are different than walls with respect to permeability limits). Carpets should never be installed directly on below grade slabs unless slabs are insulated (below or on the top surface). Carpets on uninsulated slabs are cold resulting in sufficiently elevated relative humidities within the carpet to support dust mite and mold growth.

Exterior Drainage It is always better to intercept groundwater before it gets to a foundation wall. Exterior perimeter drainage is always preferable to interior perimeter drainage.

However, in renovations, exterior perimeter drainage may not be present or may not be practical or possible. In such cases, interior perimeter drainage can be used and connected to an interior sump pump. Interior sump pits/crocks must be fitted with airtight gasketed covers to prevent soil gas entry. This interior perimeter drainage may be combined with an interior drainage layer. Where an interior drainage layer is used, it must be gas tight and vapor tight relative to the interior (see **Figure 13**). Another technique is to use an exterior impermeable material to minimize rain and groundwater entering below grade spaces (see **Figure 9**).

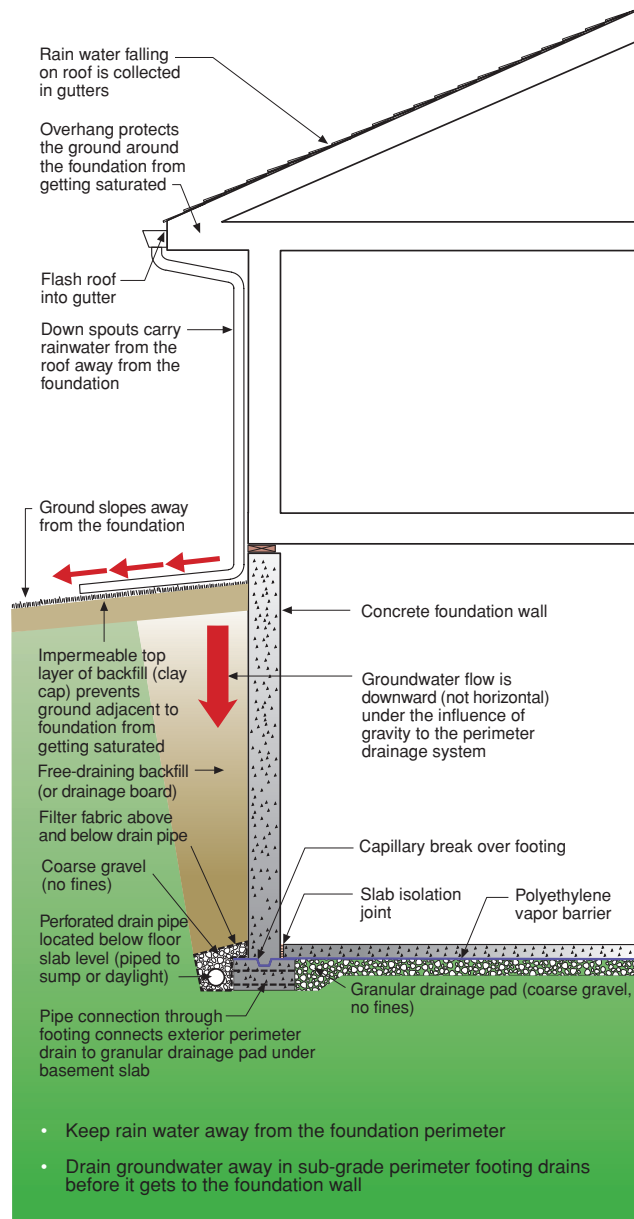

Figure 8a
Groundwater control with basements

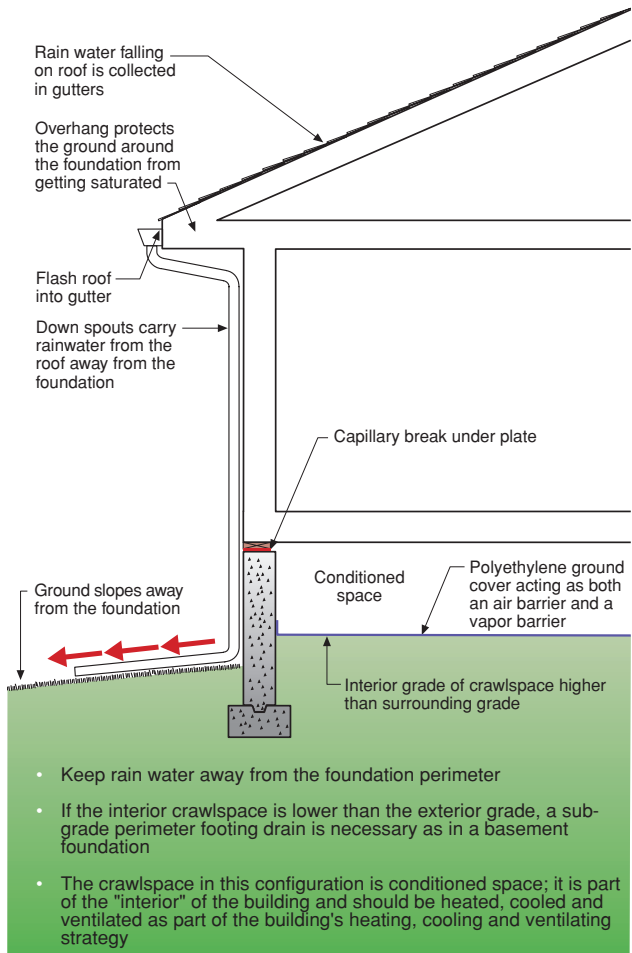

Figure 8b
Groundwater control with crawlspaces

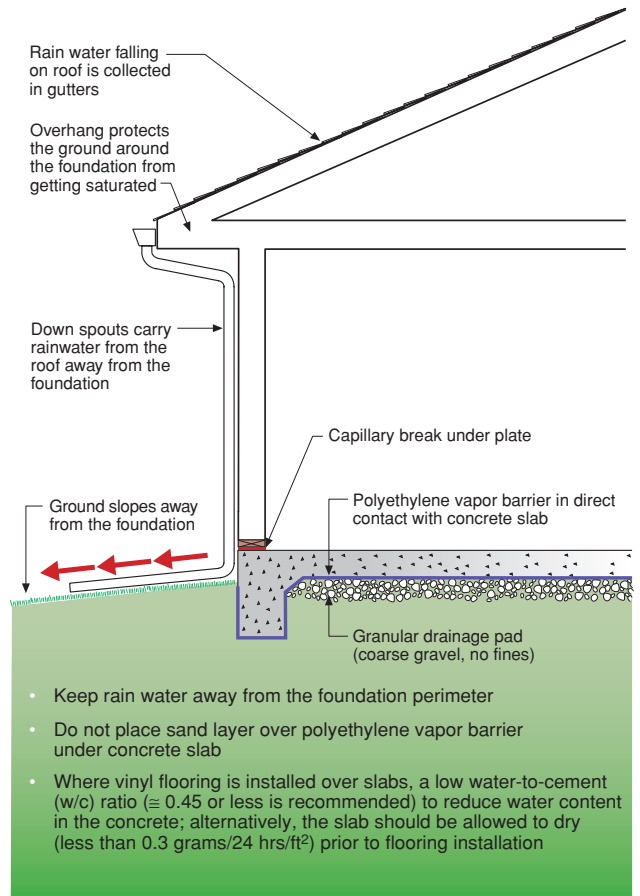

Figure 8c
Groundwater control with slabs

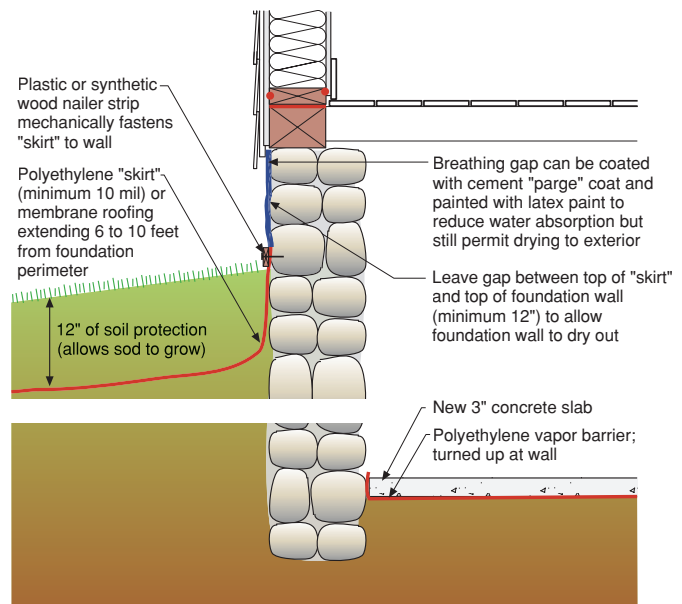

Figure 9
Using an impermeable skirt outside

- Prevents saturation of ground adjacent to existing foundation

Figure 10
Capillary rise through basement footing

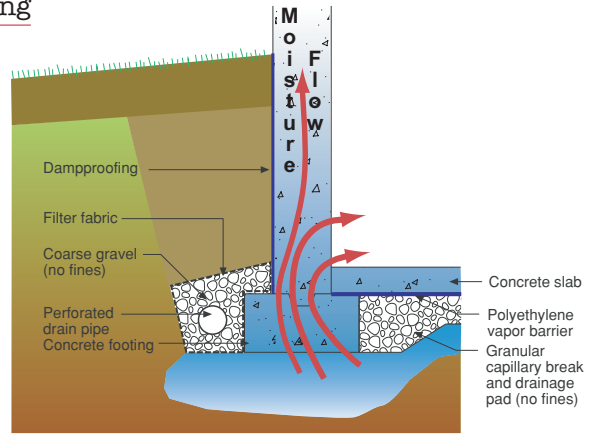

Figure 11
Capillary break over footing

- Concrete wall cold, can only dry to the interior if interior assemblies are vapor semi-permeable (permeance greater than 1 perm — i.e unfaced extruded polystyrene less than 1-inch thick); mold possible if interior assemblies do not permit drying
- Cold concrete wall must be protected from interior moisture-laden air in winter and in summer
- Basement floor slab can dry to the interior
- Thicker foam can be used if drainage is provided between the foam and the foundation wall (see Figure 14)

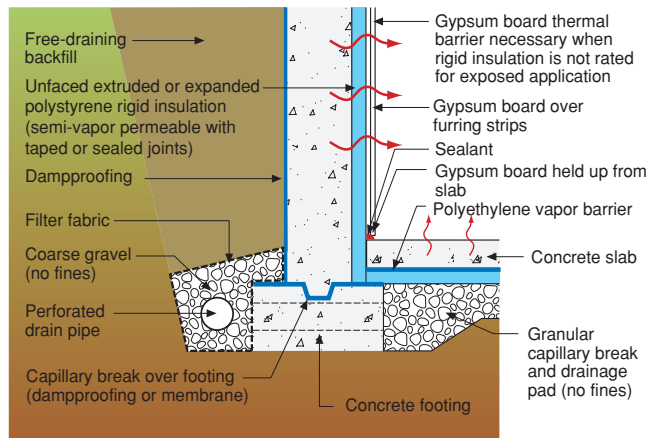

Figure 12
Capillary control for monolithic slab

- Never install a sand layer between a polyethylene ground cover and a slab; the sand layer becomes wet and holds water indefinitely; the sand can only dry upwards, not downwards, due to the polyethylene

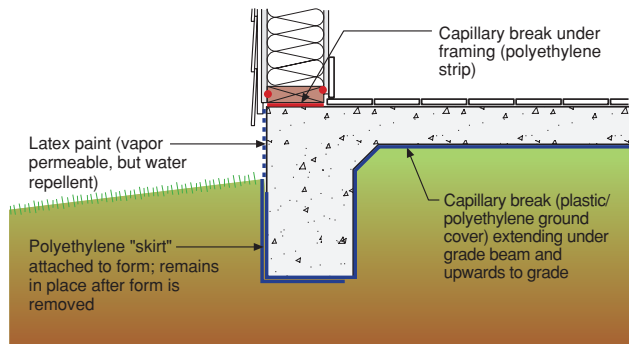

Figure 13

Interior drainage: Renovation

- Interior membrane waterproofing must be gas tight and vapor tight relative to the interior

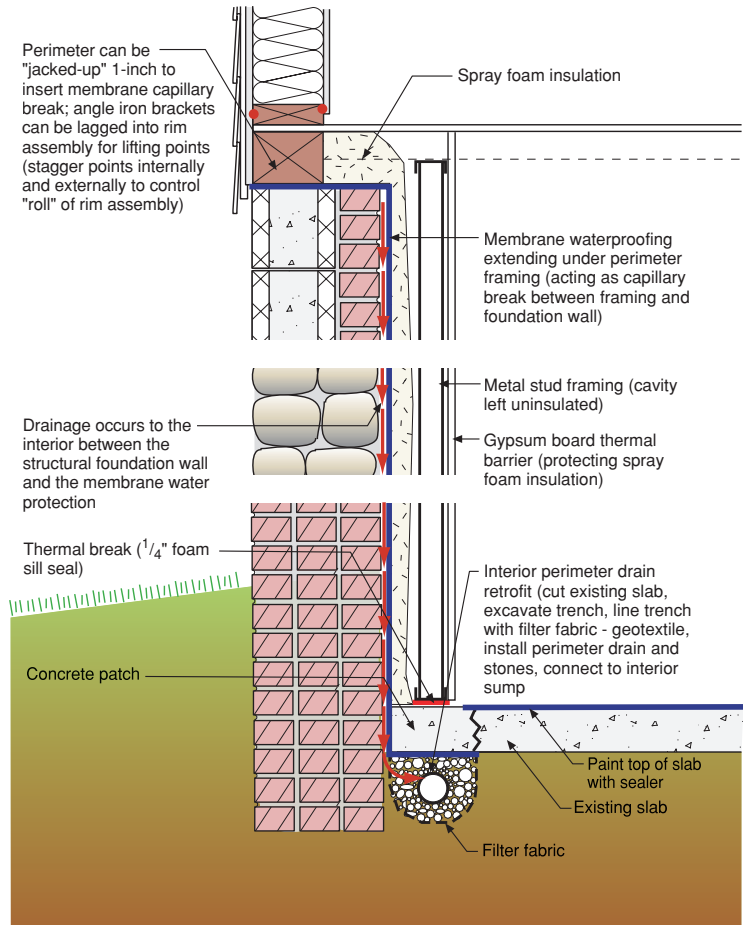

Figure 14

Interior drainage: New construction

- Interior rigid insulation must be gas tight and vapor tight relative to the interior
- This can also be a retrofit approach

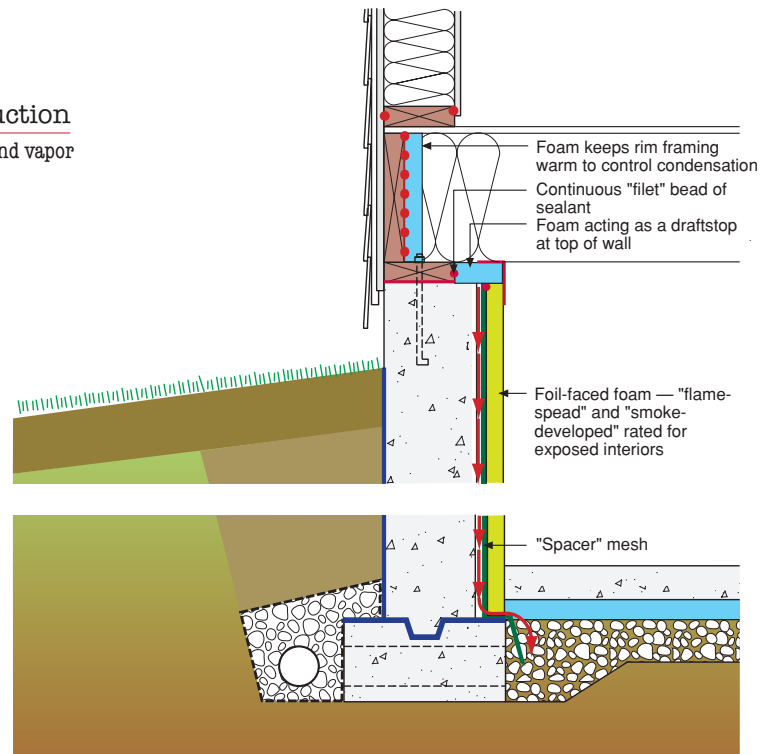

Figure 15

Slab top-side vapor control — Semi-permeable floating floor

- Extruded polystyrene should be used due to its compressive strength (expanded polystyrene can be used if furring spacing is reduced to 12" o.c. or if plywood is supported directly on foam (i.e. no furring))
- Not applicable with visibly wet slabs and where efflorescence (salts) is visible
- Avoid vinyl flooring with this assembly as vinyl flooring does not breathe

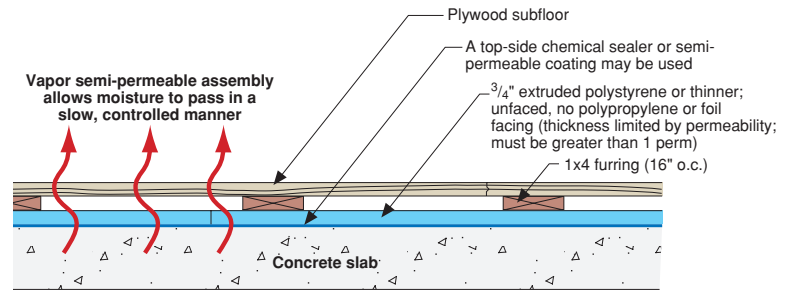
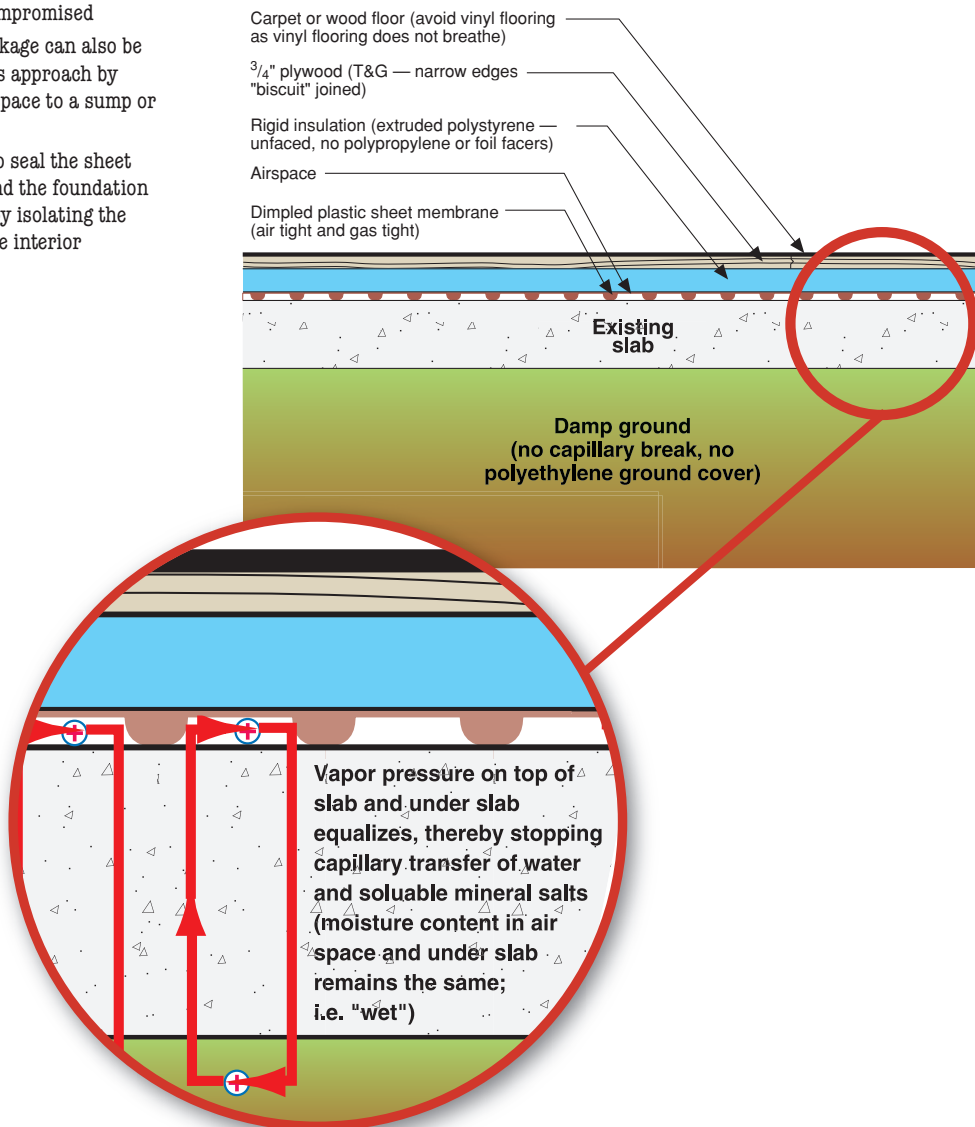

Figure 16

Slab top-side vapor control — Airspace Approach

- Works in both new construction and rehabilitation
- Plywood glued (T&G edges) to itself not mechanically fastened (no screws or nails) through foam and dimpled plastic sheet membrane so that gas barrier/air barrier is not compromised
- Groundwater leakage can also be handled with this approach by draining the airspace to a sump or floor drain
- It is important to seal the sheet membrane around the foundation perimeter thereby isolating the airspace from the interior



READ THIS BEFORE YOU DESIGN, BUILD OR RENOVATE

Plumbing

Plumbing Location Don't put plumbing in exterior walls or insulated ceilings. Exterior walls contain insulation and are subject to more extreme temperature swings than interior walls making the plumbing more vulnerable. The result can be plumbing leaks and breaks that cause significant water damage and can be the cause of mold growth. To prevent such problems, avoid whenever possible putting any cold or hot water supply pipes, steam lines, hydronic heat pipes, air conditioner condensate lines in outside walls. Not steam lines, not hydronic heat pipes, not air conditioner condensate lines, not anything that carries water.

Put plumbing in interior walls or in floors (see **Figure 17**) so when the plumbing leaks, and make no mistake about it, plumbing will leak, we can see the leak and fix it.

Bathrooms Since plumbing leaks and since we have lots of plumbing in bathrooms we'll probably have leaks in bathrooms – particularly in the—"wet areas". Don't use paper-faced gypsum board or "green board" products in wet areas such as tub and shower enclosures. It is just paper with a green color. It's best to use cement board or fiber cement board or paperless gypsum board or do it the old-fashioned way with cement plaster. Where you do use gypsum board, keep the gypsum board up off floors everywhere at baseboard locations. When the inevitable leak occurs, this space reduces the chance that the paper-faced wallboard will come into contact with water from a leak and suck it up into the wall.

Clothes Washers and Water Heaters

Clothes washers can leak, especially the rubber hose connections. Reinforced hose connectors should be used. Clothes washers should also be installed in rooms with drains and floor systems that drain to the drain with floor coverings that are not water sensitive.

It is also good practice not to put laundry rooms up on second floors (despite the convenience of locating them there) because when pipes burst and hoses break everything below them gets water damaged. A good place for laundry rooms is on slabs (at grade or in basements).

Water heaters can leak, especially when they get old, pressure relief valves leak, and drain pans for water heaters leak. Water heaters should also be installed in rooms with drains and floor systems that drain to the drain and with floor coverings that are not water sensitive. In warm climates, it is best to install them in

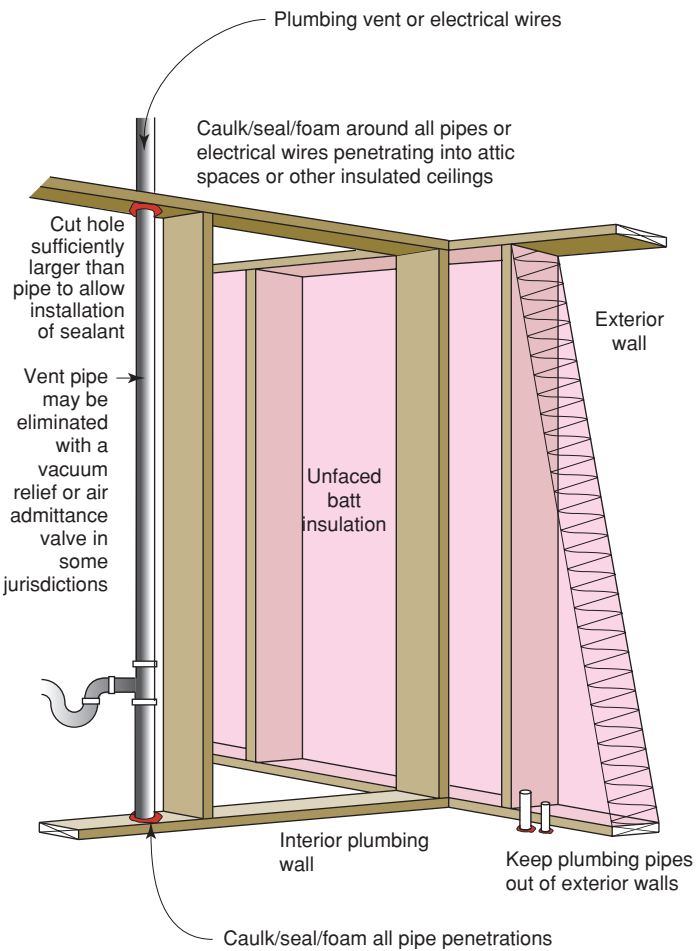

Figure 17
Locating plumbing pipes

• Sealants should be flexible, non-hardening

garages so when they leak they don't cause much damage. Never, ever install them in attics.

Because clothes washers leak and water heaters leak, shut off valves that can be used to isolate these devices should be provided. These shut off valves should be easily accessible and visible. Don't hide them behind the clothes washer or hot water heater. Single-throw shut-offs for clothes washers are effective and convenient.



Single-throw shut-off

Air Conditioning Systems These systems also can be sources of plumbing leaks. Besides cooling air, they are dehumidifiers that remove moisture in the air by condensing it on a cold coil and draining the condensate to a drain or to the outside. This involves plumbing and drain pans and therefore leakage.

Note: Installing air conditioners in attics where they can leak is as risky as installing water heaters in attics. Wherever they are located, drain pans must be constructed and installed so that they drain.

Drying

Walls Walls get wet from both the outside and the inside. And, in many cases, they start out wet due to the construction process. Therefore, walls should be designed to dry. Walls that are designed to dry to both sides (see **Figures 18** and **19**) typically perform better than walls that are designed to dry only to one side. All walls should be designed to dry to at least one side.

Poly In Walls Sheet polyethylene is an almost “perfect” vapor barrier because it does not allow any moisture in the vapor form to pass through it. This is a great feature during cold winters, but is a counter-productive feature during summers and climates that require cooling.

Although many homes with polyethylene vapor barriers in walls may not be experiencing problems due to trapped moisture, these homes may be at a higher risk for such problems, which can cause mold, than walls that dry more easily.

In new construction and significant renovations, when there is a choice of vapor retarders paper-faced cavity insulation can and should be used in place of plastic interior vapor barriers. Alternatively, cellulose cavity insulation can be used in conjunction with latex paint on gypsum board.

Building codes do not call for the installation of vapor barriers – they call for the installation of vapor retarders – and only in cool and cold climates or colder (5,400 heating degree days or greater – Zone 5 or higher – see **Figure 21**).

Note: A vapor retarder is defined by building codes as a material that has a vapor permeability of 1 perm or less (as tested by ASTM E-96 Test Method A – the desiccant or dry cup method). Sheet polyethylene has a vapor permeability of 0.1 perms— 10 times less than what is called for in the building codes.

Installing interior polyethylene as a vapor barrier on wall assemblies should be limited to very cold climates (9,000 heating degree days or greater– Zone 7 or higher).

Roofs They should be designed to dry. That means roofs should be ventilated. It is possible to design and construct unvented roofs, but this should be done only with professional design and analysis.

Installing polyethylene vapor barriers in vented roof assemblies should be limited to cool and cold climates or colder (5,400 heating degree days or greater— Zone 5 or higher). Even in Zones 5 or higher, polyethylene vapor barriers are not required in vented roof assemblies; the code does not call for their installation, the code calls for only a vapor retarder.

Basements Basements should be designed to dry to the interior (see **Figure 20**). These principles are often in conflict with some common misapplied energy conservation and moisture control practices – for example the use of sheet polyethylene as an interior vapor barrier.

Sheet polyethylene (or vapor barriers) should never be installed on the interior of interior basement insulation assemblies or on the interior of interior insulation in below grade wall assemblies

Figure 18

Classic flow-through wall assembly

- Permeable interior surface and finish and semi-permeable exterior sheathing and permeable building paper drainage plane
- Ventilation provides interior air change (dilution) and also limits the interior moisture levels during heating
- Air conditioning/dehumidification limits the interior moisture levels during cooling

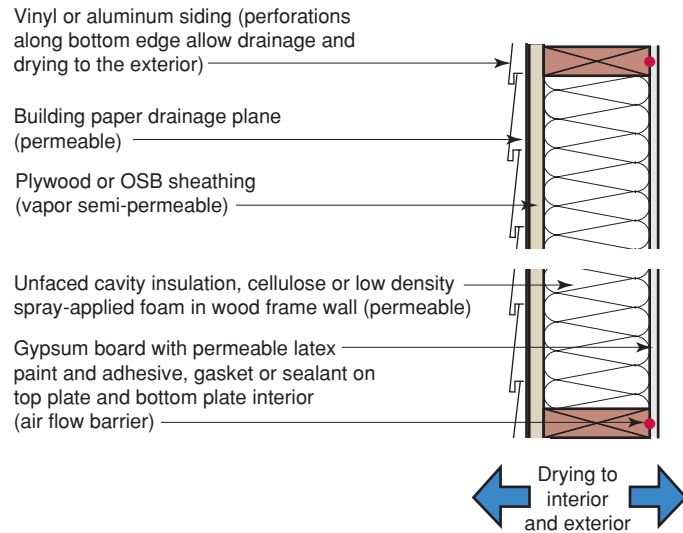
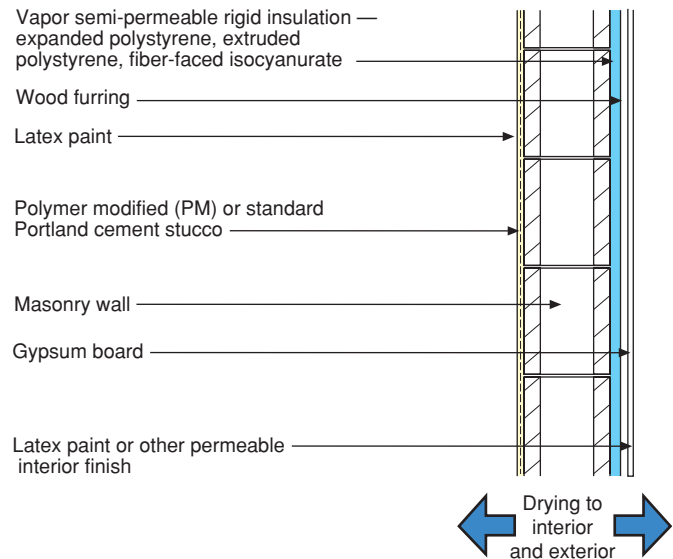

Figure 19

Masonry wall with interior rigid insulation and stucco

- The vapor semi-permeable rigid insulation and interior latex paint permit drying to the interior
- Vapor semi-permeable rigid insulation (1 perm or greater) used on the interior should be unfaced or faced with permeable skins; foil facings and polypropylene skins should be avoided
- Avoid use of metal furring or “hat” channels due to thermal bridging and impermeability; use only wood furring
- Wood furring should be installed over rigid insulation; rigid insulation should not be installed between wood furring, but should be installed directly on interior of masonry
- The exterior latex paint permits drying to the exterior



BEFORE YOU DESIGN, BUILD OR RENOVATE

READ THIS

in any climate as it prevents drying to the interior. The exception to this interior vapor barrier in basements rule is where drainage is provided between the interior vapor barrier and the assembly (i.e. exterior to the vapor barrier – see **Figure 13 — Interior Drainage: Renovations** and **Figure 14 — Interior Drainage: New construction**).

Impermeable interior finishes should be avoided, such as vinyl wall coverings or oil (alkyd) based paints. In a similar vein, vinyl floor coverings should be avoided on basement floor slabs or on slab-on-grade construction unless a low water-to-cement ratio concrete is used (less than 0.45) installed directly over a polyethylene vapor barrier – and only where slab edges are protected from capillary water (see **Figure 13 – Capillary Control For Monolithic Slab**).

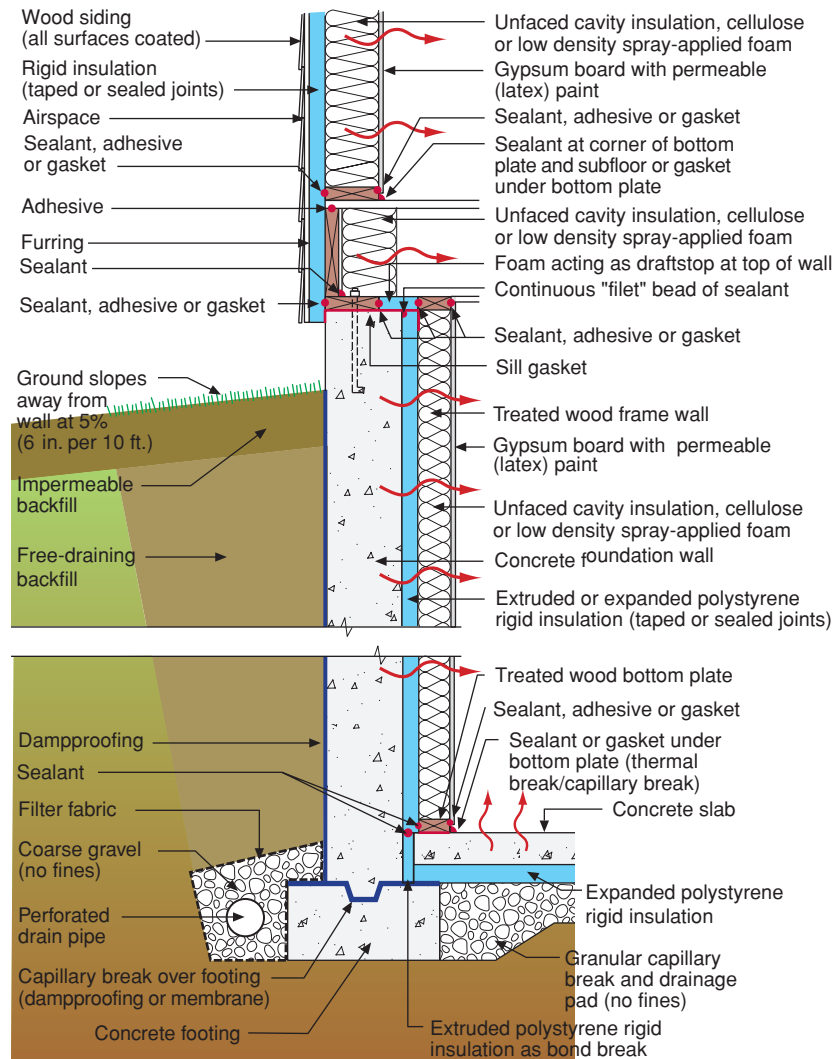
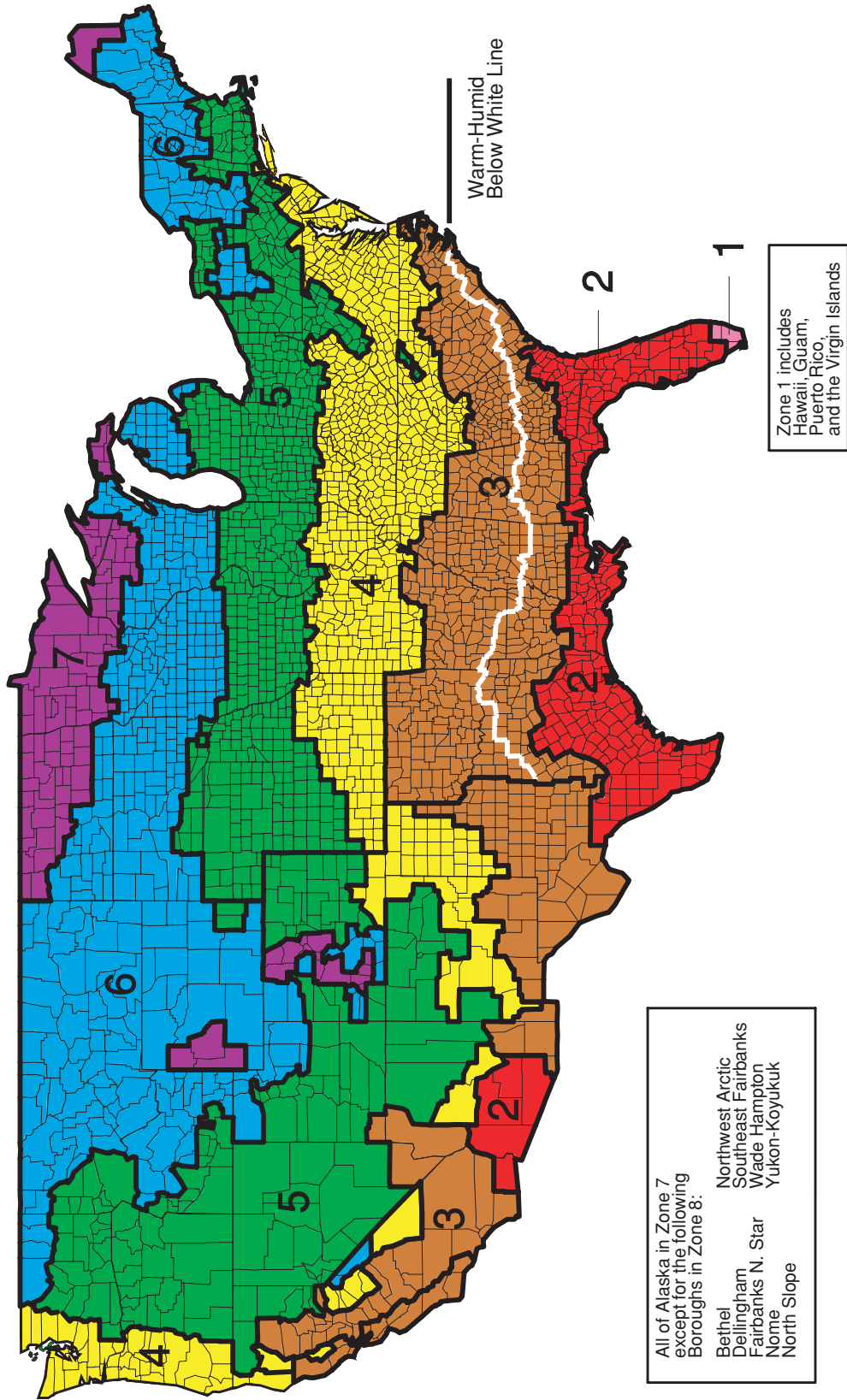

Figure 20
Internally insulated concrete basement with wood siding above

- Concrete wall cold; can only dry to the interior if interior assemblies are vapor semi-permeable; low likelihood of mold
- Cold concrete wall must be protected from interior moisture-laden air in winter and in summer
- Basement floor slab is warm, can dry to the ground (since there is no under slab vapor diffusion retarder) as well as to the interior; lowest likelihood of mold

Figure 21
Climate zones map



Air

Air transports pollutants and moisture. In order to control pollutant movement you must first control air. But in order to control air you must first enclose air. That means getting rid of the big holes. Once we get rid of the big holes, identify the building “boundaries” (and get an “enclosure”), we can control air movement within a home and between the home and the outside.

Then we can concentrate on the cold surfaces (get rid of them by insulating them) or make sure that the indoor air or the outdoor air never gets to the cold surfaces. Why do we not want air seeing cold surfaces? Because we do not want condensation. Condensation, especially the kind we don’t see, can cause mold and destroys buildings.

Finally, we can limit indoor humidity and airborne pollutants by controlling air change between the interior and exterior. Dilution is the solution to indoor pollution that cannot otherwise be prevented or removed near the source.

But none of this is possible until we first get rid of the big holes and identify the building boundaries.

Big Holes - Building Boundaries

The biggest holes in buildings often occur between basements, crawlspaces and living areas. Other major holes include bathtubs on exterior walls, ductwork in attic spaces or exterior walls, soffits, recessed lights, plumbing chases and chimneys.

Basements These areas are part of a home, within the building boundary – despite repeated attempts over the years to disconnect them. They should be designed and constructed to be dry and conditioned. This is particularly important for basements because mechanical systems are always located in basements. Do not install mechanical systems outside of a home in unconditioned space unless there is no practical alternative. If a basement is being used for storage or as living space, it needs to be kept dry to avoid mold and dust mites.

Basements should be insulated on their perimeters – they should not be insulated between floors. Ceiling basement insulation is a bad idea, especially, if the basement is wet. If the basement is wet, make the basement dry. Don’t try to disconnect the basement from the home, it only creates problems. Especially if you put mechanical equipment in the basement. The mechanical equipment connects the basement to the house.

Crawlspaces There are different ways to build healthy crawlspaces. Crawlspaces should be designed and constructed to be dry and pest-free. A dry crawlspace is good for the inhabitants and good for building durability. A dry crawlspace is less likely to have pests and termites. Make sure you control rainwater, groundwater and provide drainage for potential plumbing leaks or flooding incidents.

Crawlspaces should not be used for storage. Builders and contractors should use designs that discourage the use of crawlspaces for storage, and provide clear guidance to owners and occupants to avoid using this area for storage.

Crawlspaces should ideally be designed and constructed as mini-basements, part of the house – within the building boundary (see **Figure 22a**). They should not be vented to the exterior. They should be insulated on their perimeters and should have a continuous sealed ground cover such as taped polyethylene. They should have perimeter drainage just like a basement (when the

crawlspace ground level is below the ground level of the surrounding grade). Make sure there is good drainage away from crawlspaces.

While crawlspace venting has been viewed as good building practice and is still required by some codes, there is emerging consensus that an unvented crawlspace with insulation on the perimeter performs better in terms of moisture, durability and pest control.

Perimeter insulation rather than floor insulation performs better in most climates. The crawlspace temperatures and relative humidity track that of the house. Crawlspaces insulated on the perimeter are warmer and drier than crawlspaces insulated between the crawlspace and the house. Cold surfaces that can condense water are minimized.

A major source of summertime high humidity in crawlspaces is humid outside air entering through vents. When humid outside air comes into crawlspaces the relative humidity goes up. Since crawlspaces are cooler than the outside condensation may form on cold surfaces. Summertime ventilation in crawlspaces usually makes them wetter not drier. Wintertime ventilation makes crawlspaces colder and is not very effective at drying them. Additionally, wintertime ventilation increases the heat loss from the home – venting crawlspaces can waste energy, and can lead to freezing pipes and uncomfortable floors.

Note: The International Building Code (ICC) allows the construction of closed (unvented) crawlspaces. Contact code officials in the design phase to determine their requirements.

Figure 22a
Internally insulated concrete crawlspace with stucco wall above

- Masonry wall cold; can dry to exterior; low likelihood of mold
- Protective membrane acts as termite barrier
- Rigid insulation must be fire-rated if it is left exposed on the interior
- Building paper installed shingle fashion acts as drainage plane located behind rigid insulation

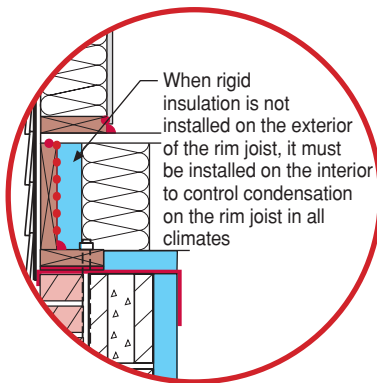

Alternative detail

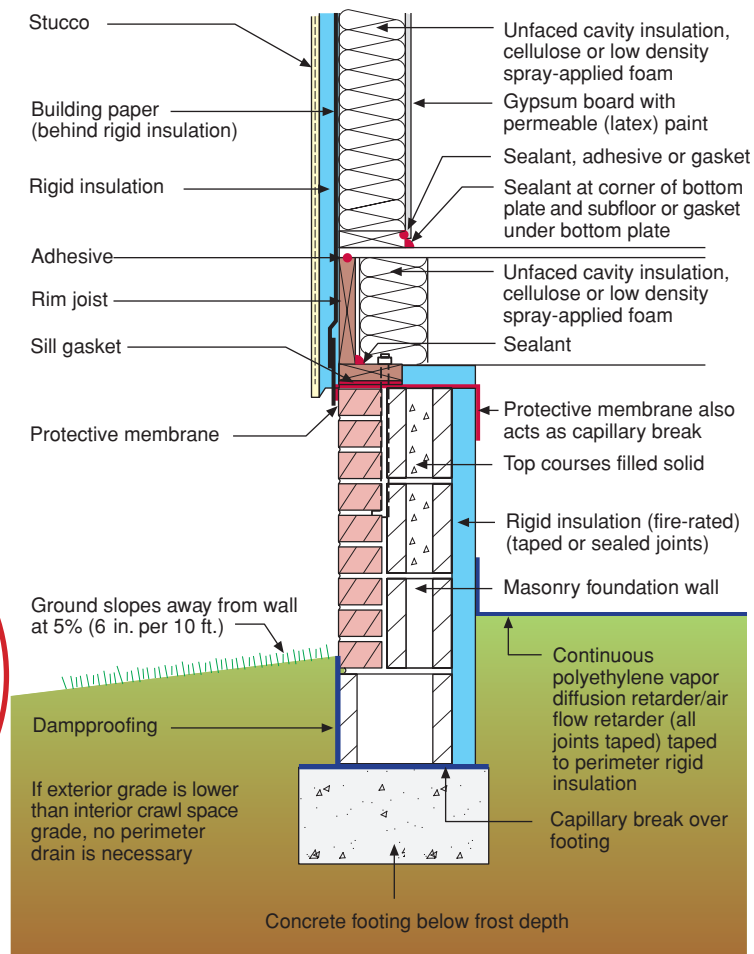

If it is not possible to treat the crawlspace as a part of the house such as in flood zones in coastal areas – or where it is not necessary such as in dry climates, it is important to construct the house such that the crawlspace is isolated from the house – outside of the building boundary. This can be accomplished by air sealing the boundary between the crawlspace and the house and by installing a vapor barrier on the underside of the floor assembly (see **Figure 22b**). This vapor barrier needs to have sufficient thermal resistance to control condensation (in both summer and winter)— as such insulating sheathing is recommended in this location. A similar approach is recommended for homes on piers (see **Figure 22c**).

No heating and cooling equipment or ductwork should be in the crawlspace if it is treated as an outside (vented) space.

In parts of the country where radon and pesticides in soil gases can be found, subslab passive ventilation is recommended (see **Figure 38b**). This also helps keep a crawlspace drier.

If possible, seal the vents in an existing crawlspace. Build new crawlspaces without vents. Where homes have both a crawlspace and a basement they should be connected together and treated together as a conditioned space (see **Figure 24**).

In many climates it is necessary to have a drying mechanism. One option is to passively connect the crawlspace to the house via floor registers or transfer grilles. The incidental air change that happens between the crawlspace and the house in this manner typically provides sufficient

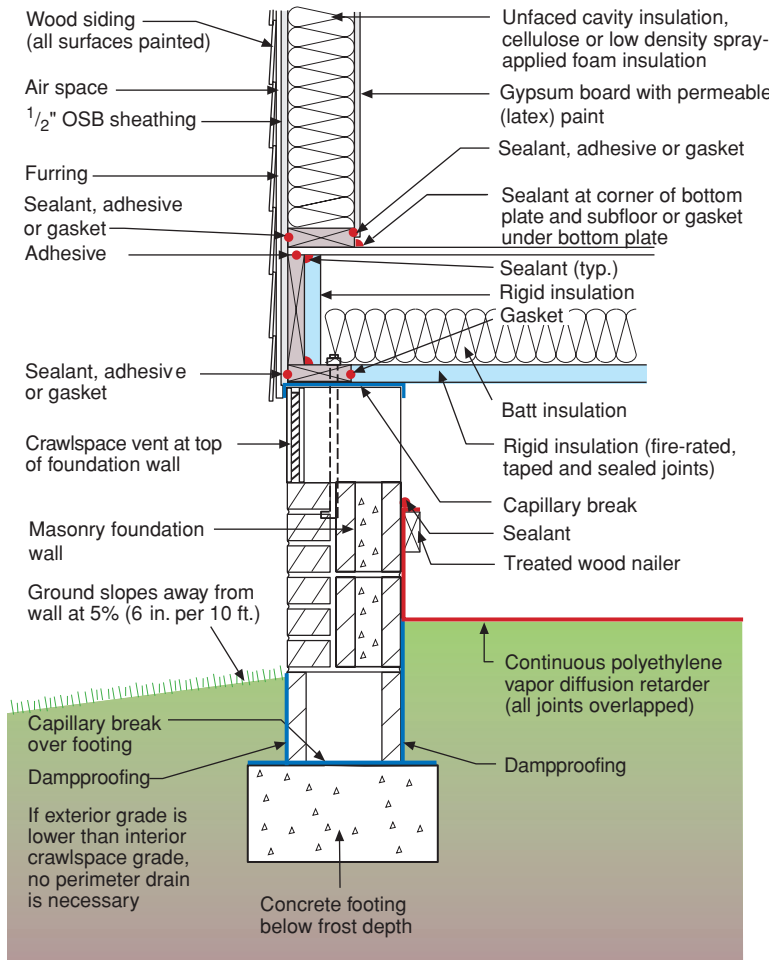

Figure 22b
Vented crawlspace

drying. A second option is to heat and cool them as if they are included as part of the home. Air must be supplied to the crawlspace from the home. This air can be returned back to the home or it can be exhausted (see **Figure 23a** through **Figure 23e**). A third option is a UL-approved dehumidifier plumbed to a sump pump or drain.

Some existing crawlspaces are sources of pollutants that cannot be satisfactorily removed or controlled. The most practical solution is to install a durable fan to exhaust air continuously from the crawlspace to the outside. The fan should be rated for continuous duty and sized according to either ASHRAE Standard 62.2 (so that it also provides ventilation for the house if desired) or at a minimum rate of 20 cfm/1000 square feet otherwise. This reverses the flow air, pulling air from the house into the crawlspace and then out of the building (**Figure 23b**).

To keep them dry all crawlspaces should have:

- Continuous, durable ground cover or liner
- Rainwater and groundwater control similar to a basement if the crawlspace is below the ground level of the surrounding grade
- Pest control measures as appropriate for the location
- Inside sloped to one or more low places for when a flooding incident occurs from a plumbing leak or rain entry – the low places should be either drained to daylight or a sump pump.

There are several ways to provide a durable ground cover or liner. The option used depends on the resources available, the frequency of people entering the crawlspace to either store possessions (not a good idea) or to maintain equipment and the severity of the pest problem.

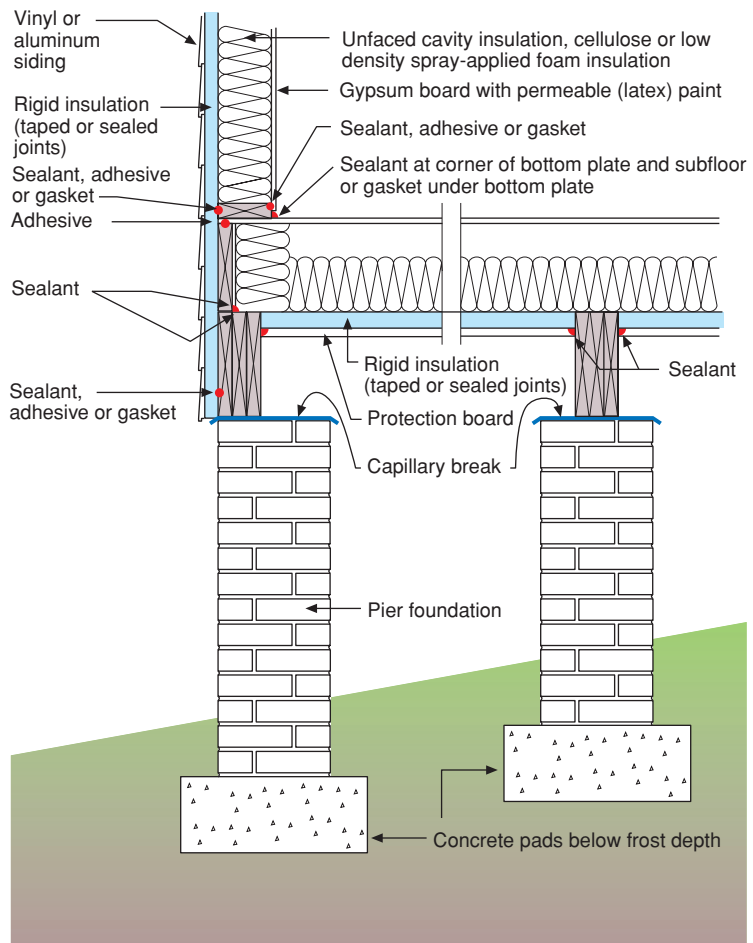
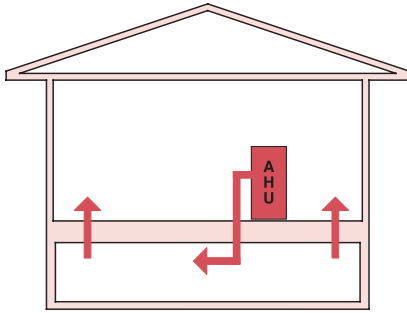

Figure 22c
Pier foundation

Figure 23
Conditioning crawlspaces



A: Supply air to crawlspace

- Minimum 2 - 4"x8" transfer grilles to house
- 50 cfm of flow per 1,000 ft² of crawlspace
- Air handler cycled at 5 minutes per hour

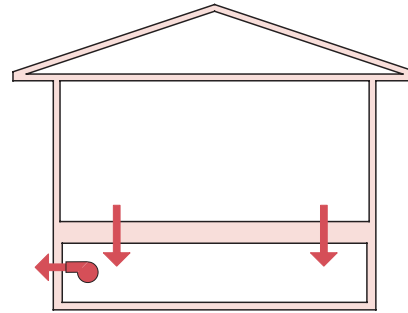

B: Exhaust fan in crawlspace

- Transfer air from house
- Fan sized at ASHRAE 62.2 whole house flow rates:
7.5 cfm/person + 0.01 cfm/ft² of conditioned area
- For a 2,000 ft² 3 bedroom house with 4 occupants:
4 x 7.5 cfm = 30 cfm
2,000 ft² x 0.01 cfm = 20 cfm
30 cfm + 20 cfm = 50 cfm (i.e. 50 cfm exhaust fan)
- Fan runs continuously

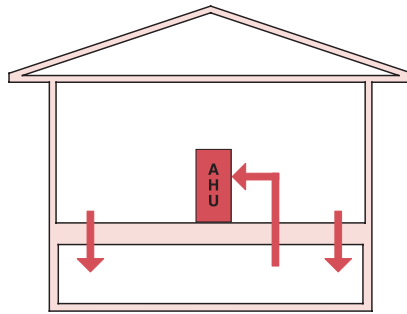

C: Return air from crawlspace

- Minimum 2 - 4"x8" transfer grilles from house
- 50 cfm of flow per 1,000 ft² of crawlspace
- Air handler cycled at 5 minutes per hour

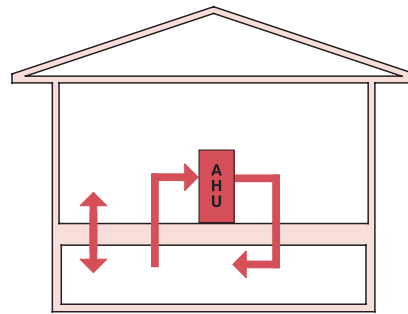

D: Supply and return to crawlspace

- Minimum 2 - 4"x8" transfer grilles from house through floor to equalize air pressures
- 50 cfm of flow per 1,000 ft² of crawlspace
- Air handler cycled at 5 minutes per hour

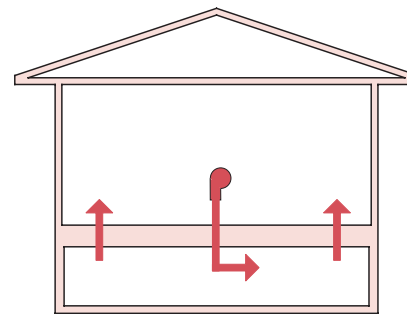

E: Supply fan in house and supply air to crawlspace

- Minimum 2 - 4"x8" transfer grilles to house
- 50 cfm of flow per 1,000 ft² of crawlspace

Figure 24
Connecting crawlspace and basement

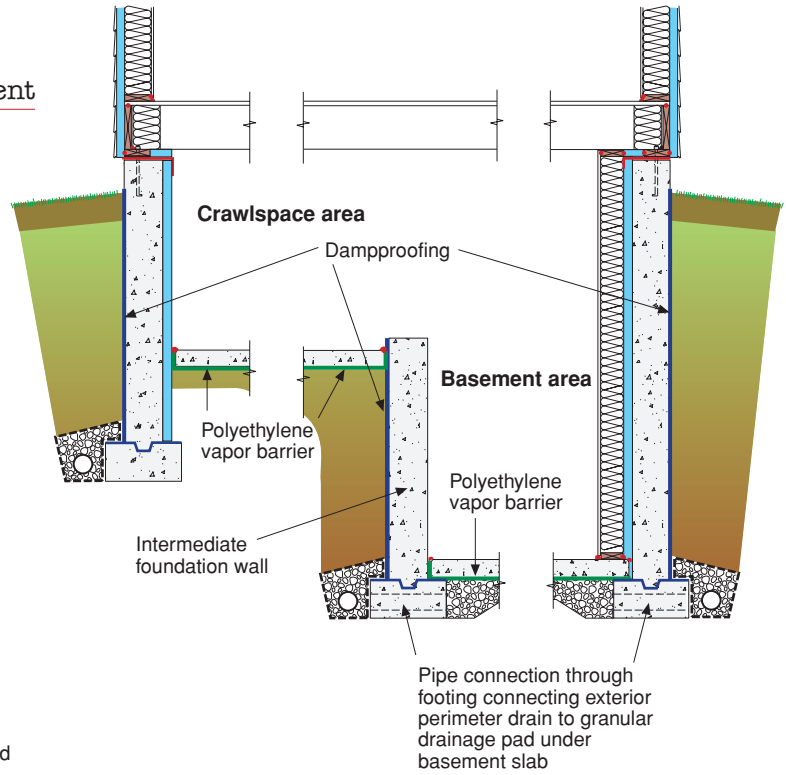

Figure 25
Utility chase construction

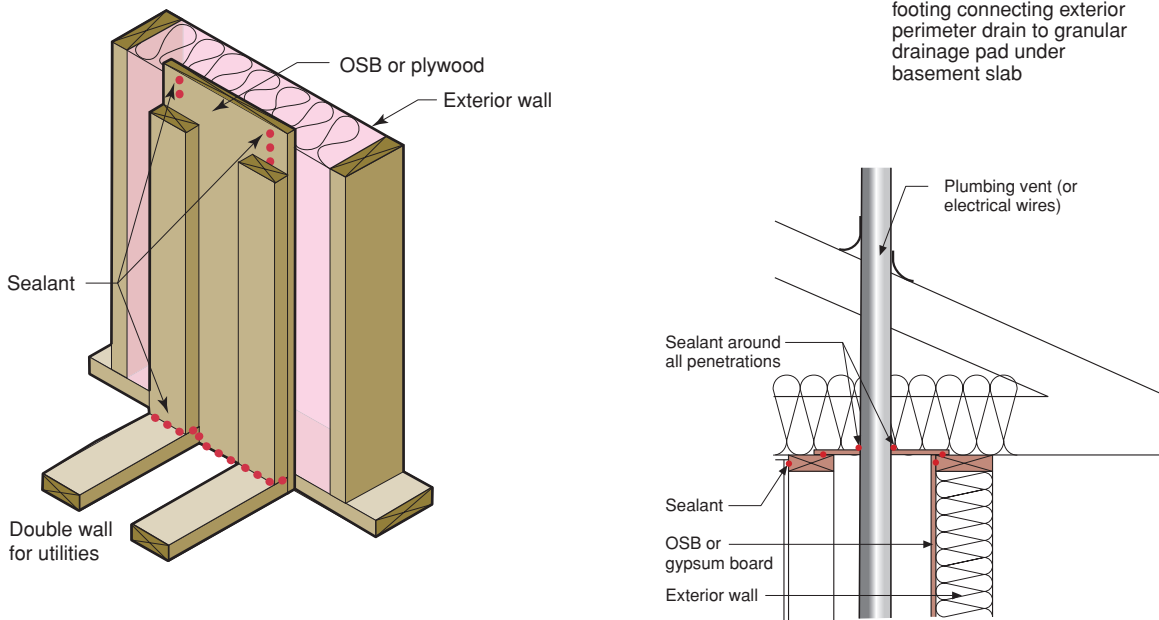

Figure 25a
Section through plumbing vent chase

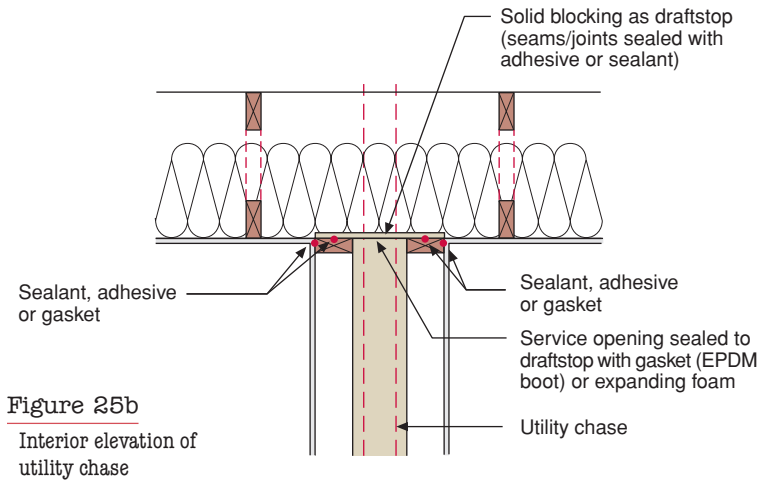

Figure 25b
Interior elevation of utility chase

Figure 26
Tub framing

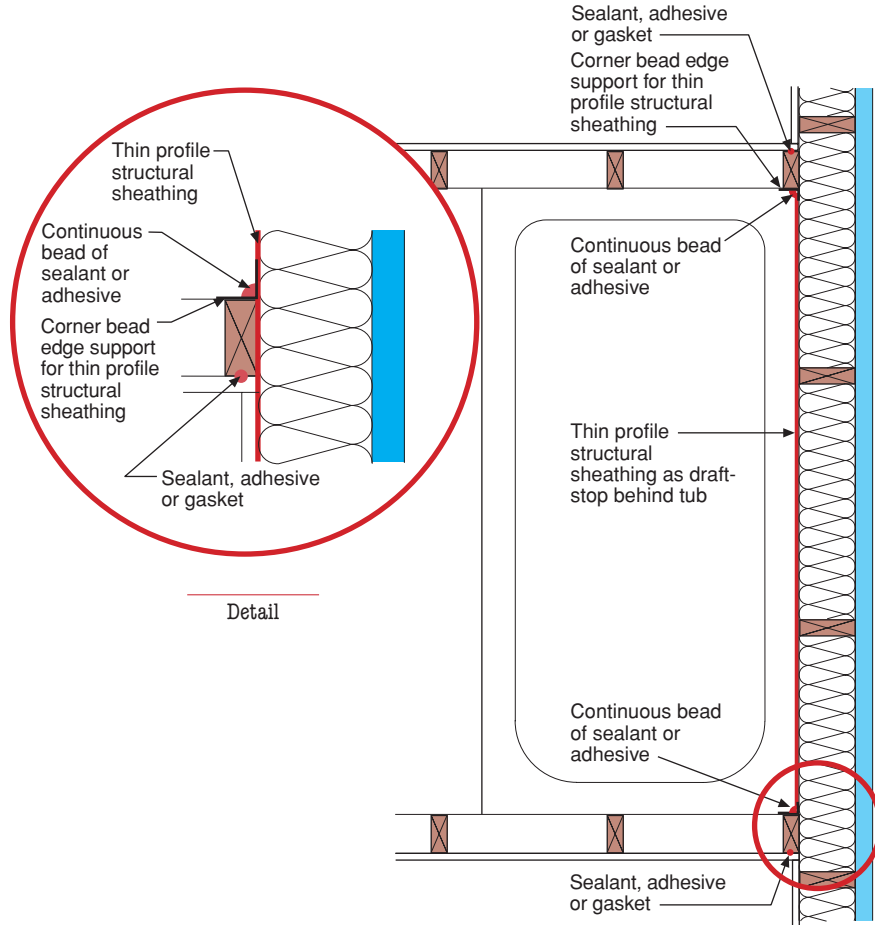

Figure 26a
Plan of tub framing

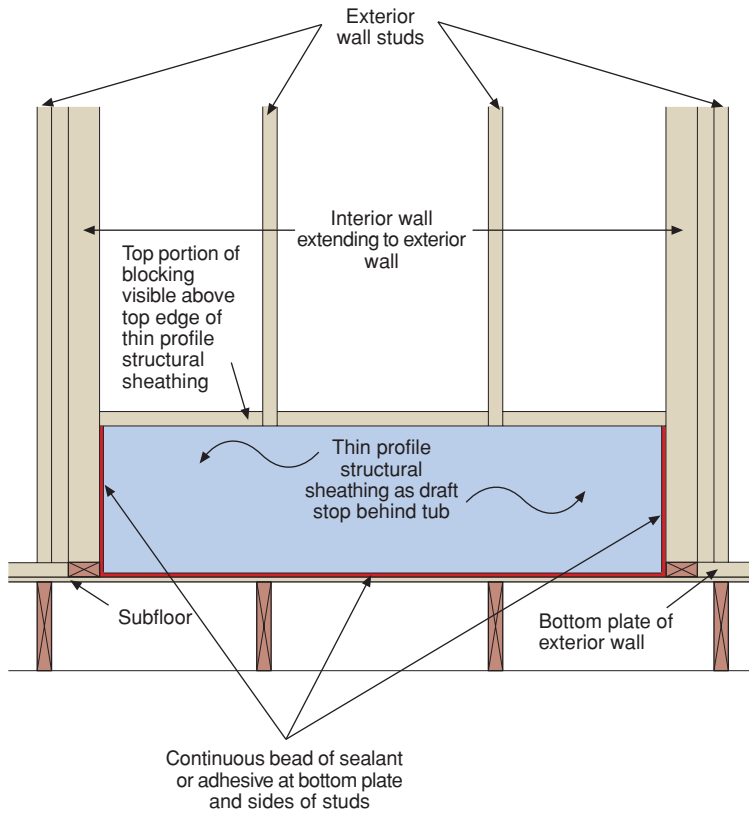

Figure 26b
Interior elevation of tub framing

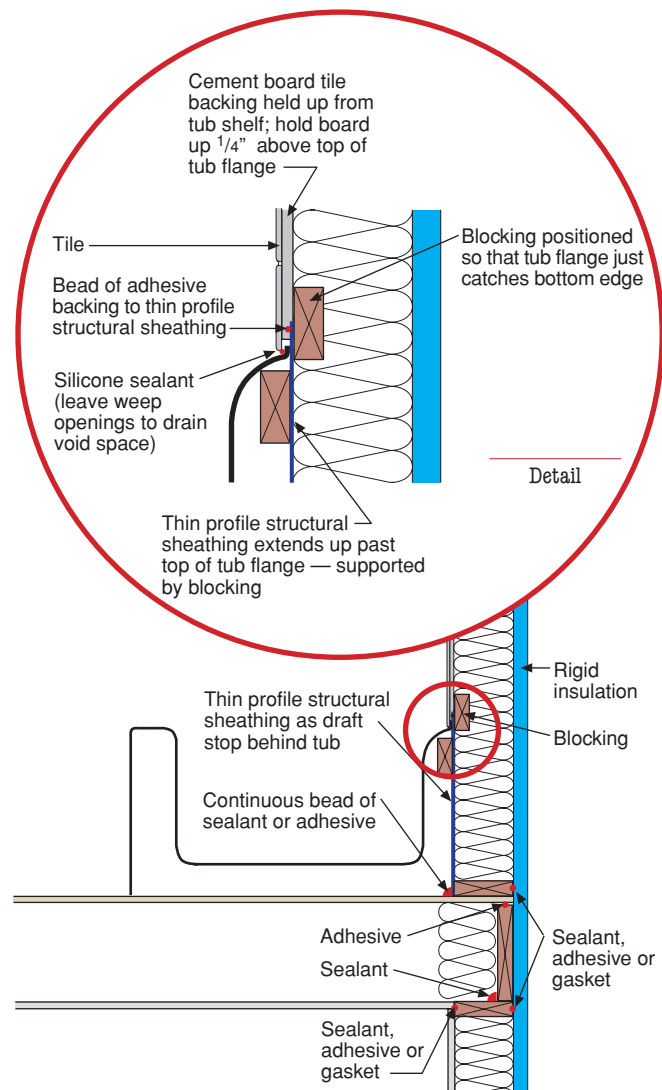

Figure 26c
Section of tub framing

- Flat blocking allows cavity insulation to be installed behind tub draftstop
- Cement board tile backing is recommended. “Green board” should not be used.

- Two inch (or thicker) “rat slab” (concrete slab) cast over a polyethylene ground cover provides the best option for durability and permanent control of pests
- EPDM rubber roofing as a continuous lining
- Overlapped, sealed and staked 10 mil poly or 6 mil reinforced poly with runners to equipment or in areas that may be accessed – runners can be EPDM rubber or linoleum
- Overlapped, sealed and staked 10 mil poly or 6 mil reinforced poly if the crawlspace is unlikely to be accessed.

One of the most important things to get right when constructing a crawlspace – especially one that is part of the house – is to make sure it remains dry during the construction process. Many builders install the sub-floor and promptly forget about the crawlspace for weeks or months as the construction process progresses. This is a huge mistake as the crawlspace is often wet and significant mold and other moisture damage can occur during this time period. It is critical that a ground cover be immediately installed (it can be a “sacrificial” ground cover – a temporary ground cover that can get covered or replaced by “the permanent” ground cover later) to prevent evaporation from the ground from damaging the structural frame. Ground water must be kept out of the crawlspace throughout the construction process and the crawlspace must be protected from rainwater”– or dried immediately after a rainstorm. This can often be done rather easily

with passive ventilation (leaving gaps in the sub-floor) or by installing a temporary fan. Ponding rainwater on the groundcover should be removed using a shop vac or the groundcover can be punctured to allow the water to drain down into the ground – the ground cover can then be patched if it is the permanent groundcover— or the hole left if it is the temporary ground cover.

Bathrooms Bathtubs and shower enclosures are rarely draft stopped (air sealed) with rigid materials such as sheathing or gypsum board (see **Figure 26**). Most people forget that cavity insulation is just a filter or screen for air. Just leaving insulation behind a tub is like leaving your front door open – forever.

Air Handlers and Ductwork Avoid placing ductwork and air handlers in attics, air handlers in garages or ductwork in walls because leaks are a problem. Leaky ducts and air handlers located in attics are one of the major sources of ice-damming problems. During rehabilitation, move the air handler and ductwork from attic and exterior walls.

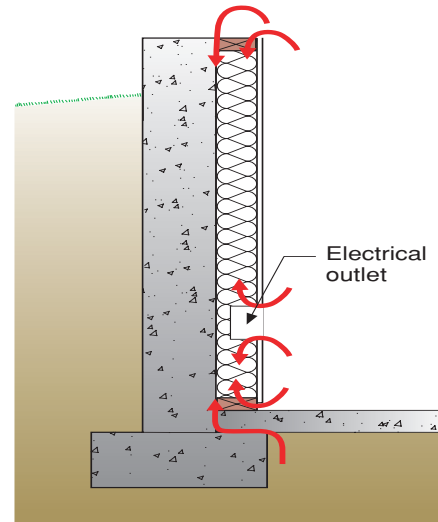

Figure 27
Sources of air transported moisture

Wherever you install ductwork, ducts should be tight. How tight? Flex duct systems should leak at no more than 5 percent of their flow (as tested by pressurization testing at 25 Pa) and sheet metal duct systems should leak at no more than 10 percent of their flow (as tested by pressurization testing at 25 Pa).

Attics Vented attics should have airtight ceilings that separate the vented attic from the conditioned part of the home. Soffits, chimneys, plumbing vent pipes, chases, dropped ceilings all require draftstops. Similarly, scuttleholes and drop-down stair openings should be air tight.

Utility Walls Another big hole is the utility wall where it intersects exterior walls and ceilings or where exterior walls are padded out to provide space for utilities (see **Figure 25**).

Cold Surfaces

Condensation happens on cold surfaces. One of the best techniques for controlling condensation is to eliminate cold surfaces.



Rigid insulation can be installed in basements above concrete floor slabs and coupled with a floating floor

Windows The coldest surfaces in homes usually are windows. Windows should never (except for short periods in unusually cold weather) have condensation on the inside. This is a wintertime problem even in warm climates. In hot-humid climates, windows often sweat on the outside during the summer. Interior window surfaces must be warm. At a minimum, windows must be double glazed with non-thermally conductive frames. Avoid aluminum extrusion windows without thermal breaks. Window frames

should be constructed from wood, vinyl or fiberglass. Wood windows can be clad with vinyl or aluminum for maintenance reasons.

Older, single pane windows will be cold and will have condensation on them. This problem occurs everywhere, not just in cold climates. They should be replaced, if possible.

In very cold climates (Zone 7 or higher, see **Figure 21**) window glazing should be low E (U-value less than 0.4). In all other climates, window glazing should be low E² (spectrally selective, SHGC less than 0.4, U-value less than 0.4). The increased cost of such glazing is readily offset by a reduction in the size of the mechanical conditioning system.

Metal Studs This type of stud is 300 times more conductive than wood studs. They are prone to condensation and ghosting. Metal studs should never be used with cavity insulation because it makes them even colder. If metal studs are used they should be limited to interior walls or to the interior of rigid insulation assemblies. Metal studs should never be used below grade unless they are separated from slabs with thermal breaks (“sill gasket”) and separated from foundation perimeter with rigid insulation.

Below-Grade Walls The main problem with below grade walls comes during the summer when warm moist air comes in contact with basement cold surfaces (see **Figure 27**). Basement walls should be insulated with non-water sensitive insulation that prevents interior air from contacting cold basement surfaces. The best insulations to use are foam based and vapor semi-permeable. Vapor semi-permeable materials allow the basement wall assemblies to dry to the interior. No interior vapor barriers should be installed in basements – ever – because they trap moisture inside the assemblies.

One of the worst assemblies for basement walls from the perspective of mold and moisture problems is a foundation wall that is internally framed and insulated with fiberglass cavity insulation and covered with a plastic vapor barrier. Metal studs only further aggravate the problem. Air gets in behind the framing and condenses on the cold surfaces. Alternatively, moisture from the foundation enters the internal framing. The moisture is trapped within the foundation assembly by the vapor barrier and deterioration occurs.

All bottom plates of below grade frame walls should be thermally isolated from basement floor slabs with thermal breaks. Commonly available “sill gasket” ($\frac{3}{8}$ - inch thick foam – $3\frac{1}{2}$ -inches wide) is an excellent thermal break under bottom plates.

Concrete Slabs If basement spaces or below grade spaces (garden apartments) are designed and constructed to be occupied, continuous rigid insulation should be installed under concrete floor slabs to raise the temperature of floor coverings to control mold and dust mites. Alternatively, rigid insulation can be installed above concrete floor slabs and coupled with a floating floor.

It is always a good idea to install a dehumidifier in all basement spaces. The dehumidifier should be plumbed directly to a condensate drain.

Other Preventative Measures All cold water pipes should be insulated to control summer condensation.

Wood framing details, particularly in corners, should be constructed “open” in order to allow the installation of insulation and reduce thermal bridging (see **Figure 28** and **Figure 29**). Headers should be designed to accept insulation as shown in **Figure 30**.

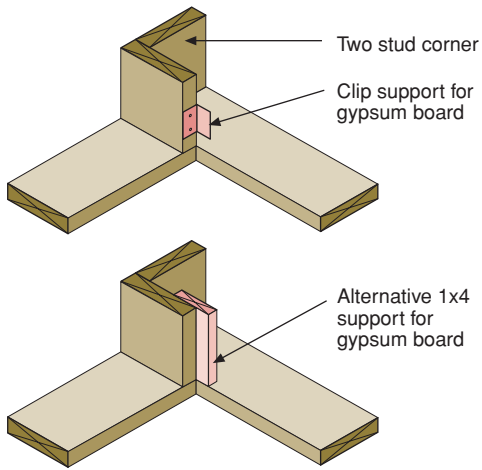

Figure 28
Corner framing

Open to interior to allow insulation installation

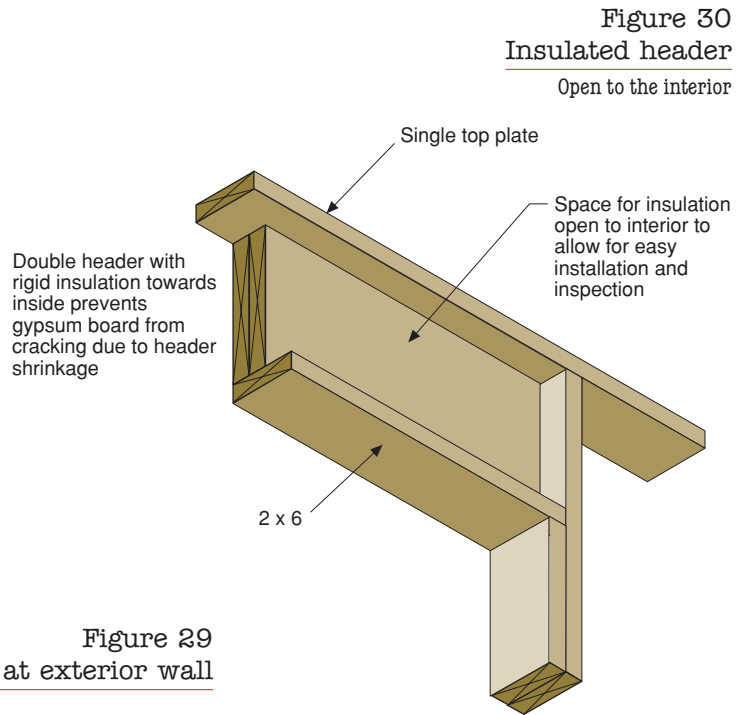

Figure 30
Insulated header

Open to the interior

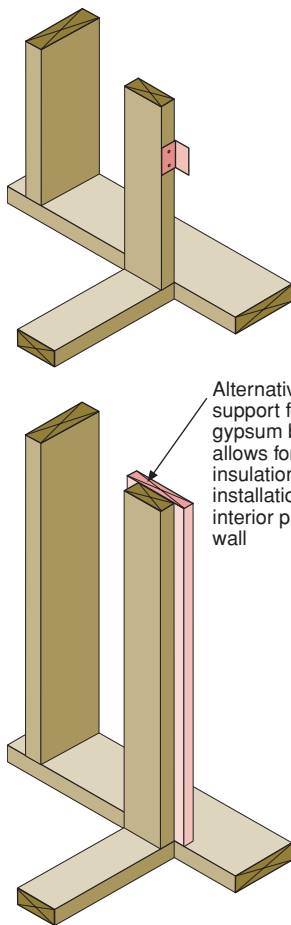
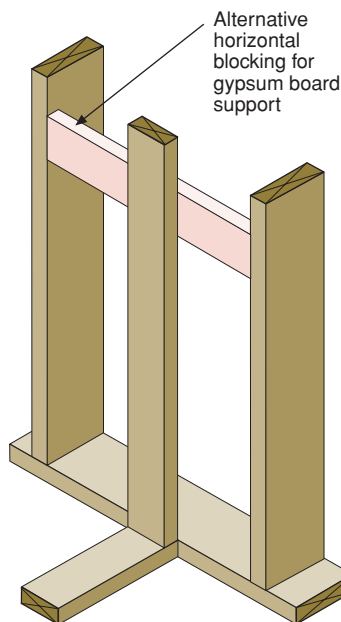

Figure 29
Interior wall at exterior wall



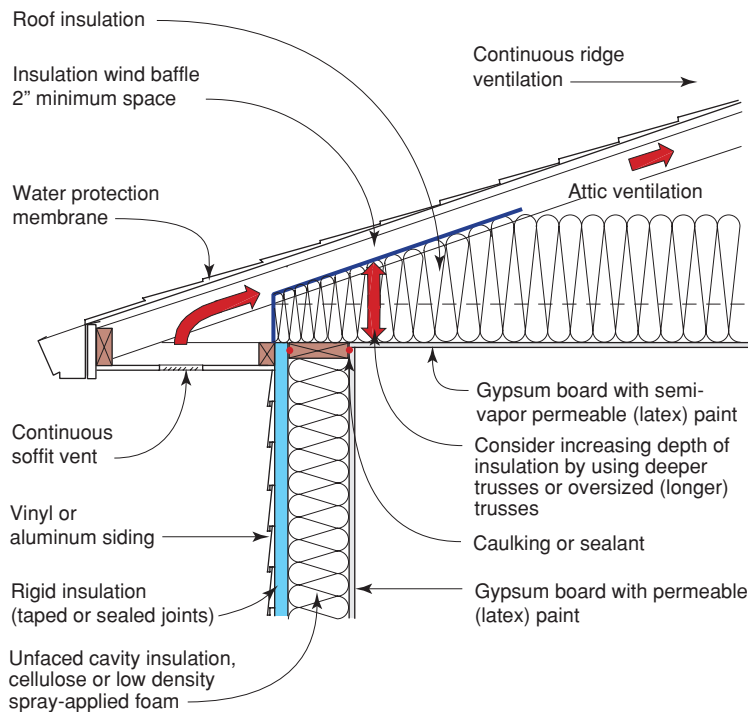

Figure 31
Baffle installation

- Roof insulation thermal resistance (depth) at truss heel (roof perimeter) should be equal or greater to thermal resistance of exterior wall

Attic insulation at exterior walls should be protected from wind wash by placement of a wind baffle (see **Figure 31**).

Indoor Humidity and Airborne Pollutants

Indoor humidity and airborne pollutants are both controlled by ventilation. There are two kinds of ventilation: spot ventilation and dilution ventilation. Both are necessary in a healthy home. Spot ventilation deals with point sources of pollution such as bathrooms and kitchens (see **Figure 32**). Dilution ventilation deals with low-level pollutants throughout the home.

This ventilation is in addition to the use of operable windows.

Kitchen and Bath Fans Every home needs to have exhaust from kitchens and from bathrooms. In kitchens, recirculating fans should be avoided because they become breeding grounds for biologicals, a major source of odors, and in all cases allow grease vapors to coat surfaces throughout the home. Kitchen range hoods must be exhausted to the outside to remove moisture, odors and other pollutants.

Bathroom fans must exhaust to the exterior – even bathrooms with operable windows. No exceptions. Low sone fans (less than 3 sones) are recommended because they are quiet (so they are more likely to be used) and more durable (in order to make them quiet they must be made durable).

Clothes Dryers Always vent dryers to the outside. Clothes dryers are huge sources of moisture as well as pollutants.

Dilution ventilation can be provided three ways: exhaust, supply or balanced (see **Figure 33**). In all cases, it should be continuous and fan powered. ASHRAE Standard 62.2 should be followed to establish dilution ventilation rates – for all homes, new or renovated.

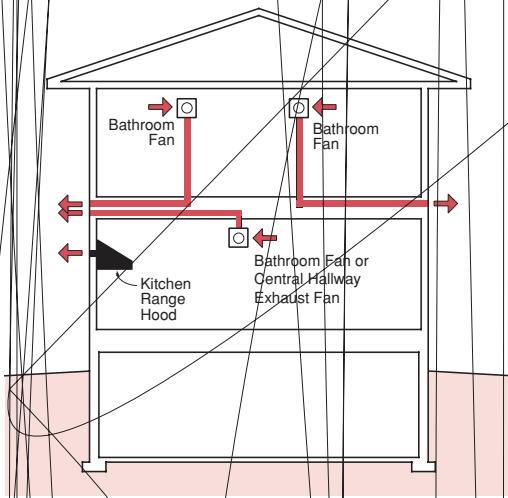

Figure 32
Exhaust ventilation system with point source exhaust

- Individual exhaust fans pull interior air out of bathrooms. One of these fans is selected to also serve as the exhaust ventilation fan for the entire building that operates continuously. Alternatively, an additional centrally located (hallway) exhaust fan can be installed.
- Replacement air is drawn into bathrooms from hallways and bedrooms providing circulation and inducing controlled infiltration of outside air.
- Kitchen range hood provides point source exhaust as needed.

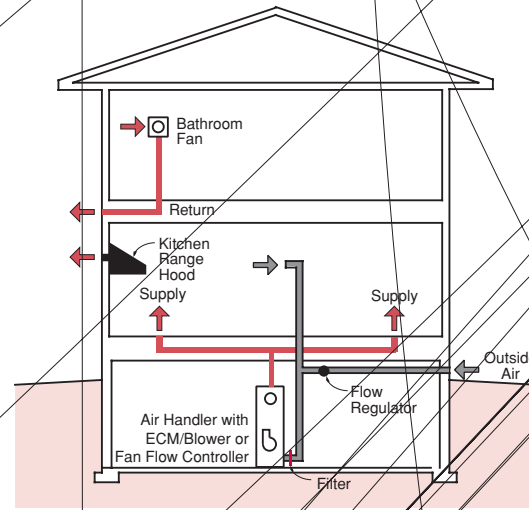
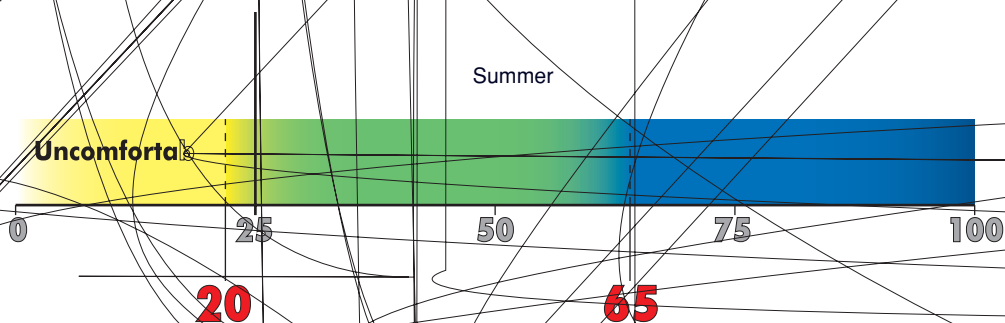

Figure 33
Supply ventilation system integrated with heating and air conditioning

- Air handler with electrically commutated motor (ECM)/blower runs continuously (or operated based on time of occupancy) pulling outside air into the return system
- A flow regulator provides fixed outside air supply quantities independent of air handler blower speed
- House forced air duct system provides circulation and tempering
- Point source exhaust is provided by individual bathroom fans and a kitchen range hood
- In supply ventilation systems, and with heat recovery ventilation, pre-filtration is recommended as debris can affect duct and fan performance reducing air supply
- Outside air duct should be insulated and positioned so that there is a fall/slope toward the outside to control any potential interior condensation. Avoid using long lengths of flex duct that may have a dip that could create a reservoir for condensation
- Mixed return air temperatures (return air plus outside air) should not be allowed to drop below 50° Fahrenheit at the design temperature in order to control condensation of combustion gases on heat exchanger surfaces

Figure 34
Relative humidity and comfort

* For 80% or more of the occupants in a space



The key to dilution ventilation is good distribution. Outside air should be provided throughout the house. Forced air duct systems can be excellent distribution systems (either by directly providing outside air or by providing mixing of interior air). Where duct distribution systems do not exist, multiport exhaust strategies can be used.

Most individuals are comfortable where relative humidity is in the 20 percent to 65 percent range (see **Figure 34**).

During the coldest part of the winter, indoor relative humidity should be kept low – but in the comfort range (see **Table** below). During summer months, indoor relative humidity (in air conditioned buildings) should not exceed 70 percent for extended periods of time (more than several days). In hot and humid climates this may only be possible with supplemental dehumidification (a stand alone dehumidifier plumbed to a condensate drain) – especially in small units with very little solar heat gain.

Recommended Not-to-Exceed Interior Relative Humidities*

Zone 5	35% relative humidity
Zone 6	30% relative humidity
Zone 7	25% relative humidity

* During winter (December, January, February)

Formaldehyde and other emissions from particleboard can be harmful. To reduce emissions from particleboard surfaces, reduce the amount of particleboard. Use wire shelving in closets. Wire shelving is easy to clean and permits air circulation. With kitchen and bathroom cabinets constructed from particleboard, the exposed particleboard sources can be sealed with 100 percent acrylic paint or clear sealant.

Pressures

Air pressure differences cause air to move. That is both good and bad. Air change is good when it causes dirty air to be replaced with clean air. Air change is bad when dirty air is brought into a home. The bad air change is commonly associated with high negative air pressures (suction) in homes. High negative pressures can draw pollutants (such as radon and soil gas) into homes from below grade. High negative pressures can also cause problems with furnaces, boilers and water heaters. Additionally, high negative pressures can cause smoke and odors to be drawn from neighboring units.

High negative pressures can be avoided several ways. The first is to seal forced air ductwork, particularly on the return (or suction) side (see **Figure 35**). The second is to provide air pressure balancing between rooms (transfer grilles) when forced air systems are used (see **Figure 36**). The third is to compartmentalize (isolate) multifamily units and high rises to limit airflow between floors.

Good duct layout and proper placement of air handlers provide thermal comfort and avoid the introduction of polluted air into homes (see **Figure 37**).

An effective way to use air pressure differences to capture and vent pollutants is through a sub-slab ventilation system (see **Figure 38a** through **Figure 38c**). It is a good idea to construct all floor slabs, both below grade and on grade, with sub-slab ventilation.

Figure 35

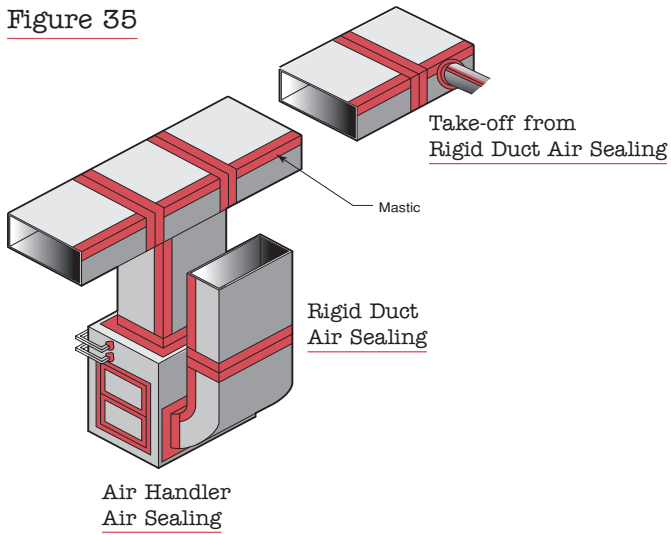

Figure 36
Transfer grille

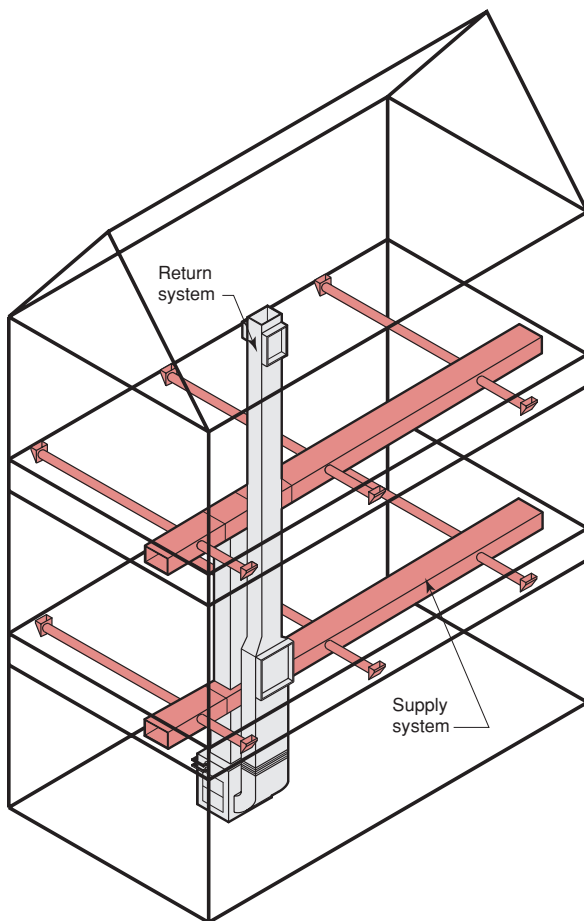
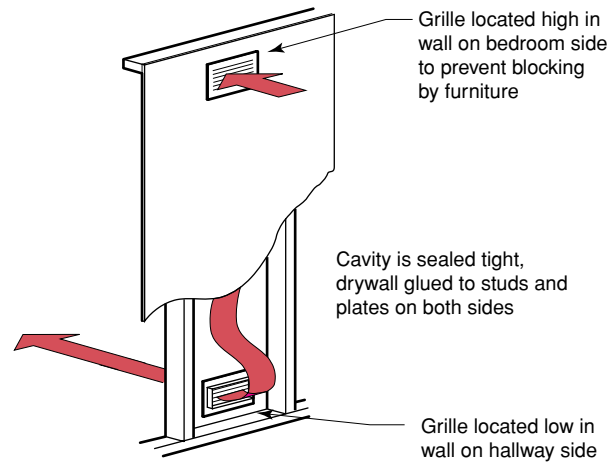

Figure 37
Air handler and duct layout

- Air handler centrally located to minimize duct runs
- No ductwork in exterior walls or attic
- Return high in hallway of upper floor
- Return low in hallway of main level
- Only fully “hard”-ducted returns connected directly to air handler should be used; no panned floor joist returns; no stud cavity returns should be used
- Either return ducts in bedrooms or transfer grilles

Figure 38a
Soil gas ventilation system —
basement construction

- Granular drainage pad depressurized by passive stack action of warm vent stack located inside heated space
- Avoid offsets or elbows in vent stack to maximize air flow

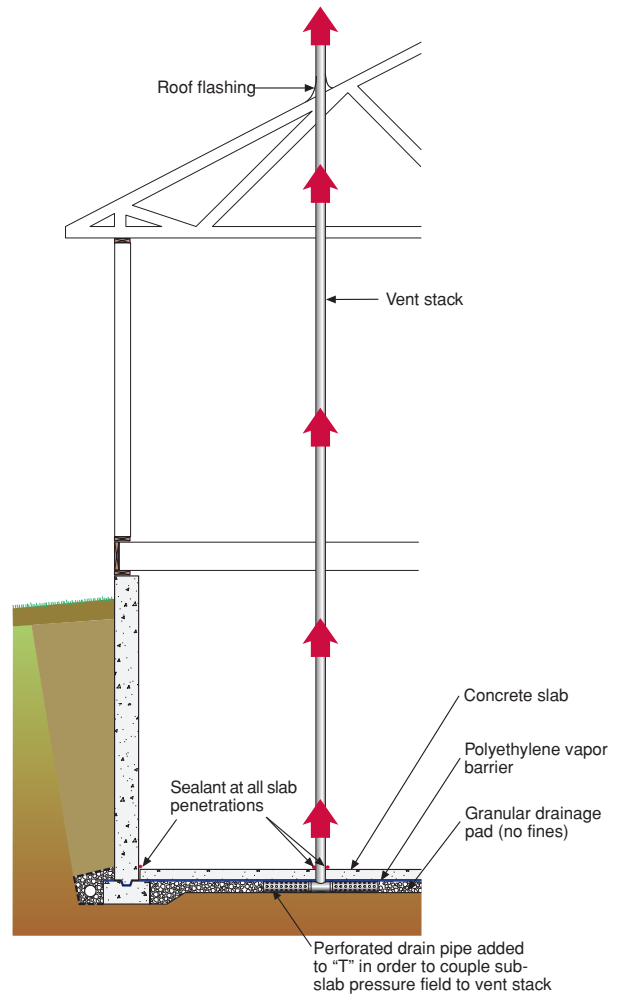

Figure 38b
Soil gas ventilation system —
crawl-space construction

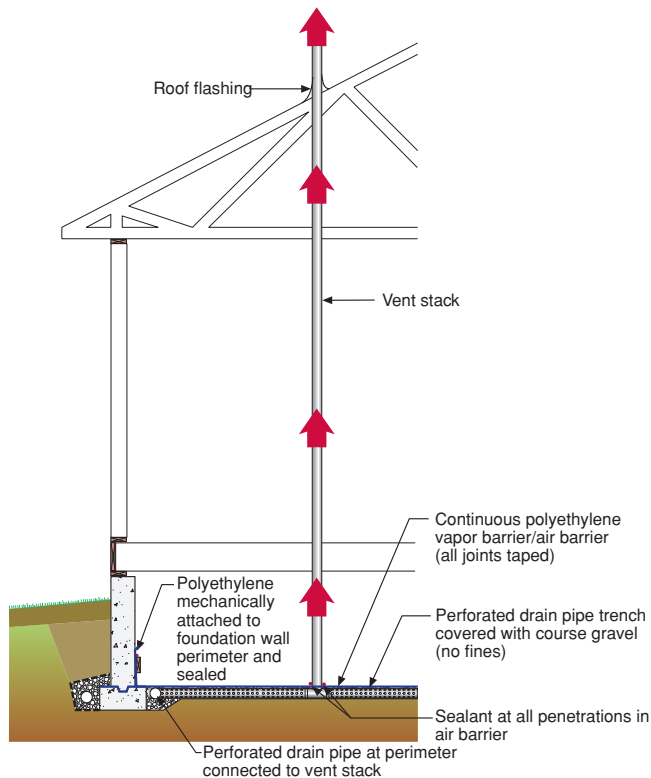
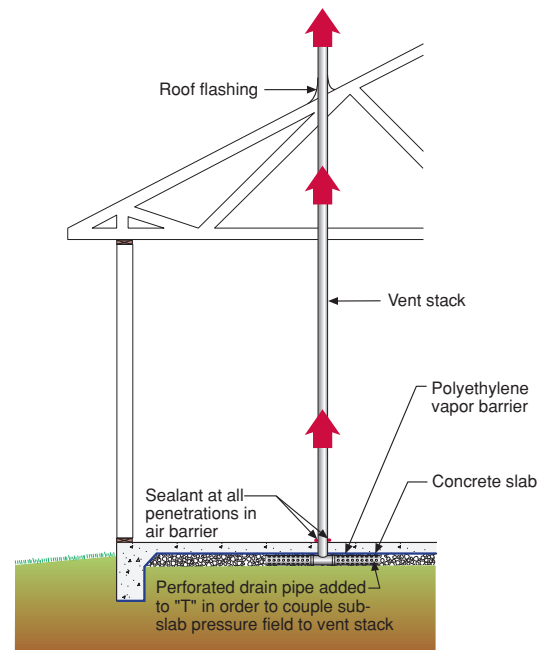

Figure 38c
Soil gas ventilation system —
slab-on-grade construction



Combustion

Carbon monoxide (CO) is a major health threat in homes. If fuel burning appliances do not operate properly, they can produce carbon monoxide. However, CO poisoning is preventable. If combustion appliances are installed in homes, occupants should be educated about the health effects and symptoms of CO poisoning and CO monitors should be installed in the home.

When something is burned it produces by-products of combustion — particularly carbon monoxide and soot — that are unhealthy. Even “clean” burning flames produce large quantities of water vapor, nitrogen oxides, sulfur oxides and carbon dioxide — all of which can lead to problems for people. Products of combustion should not be found in the indoor air of a healthy home.

Combustion Appliances

Gas cook tops and gas ovens produce products of combustion. These appliances can be large sources of carbon monoxide. Gas cook tops and gas ovens should only be used in combination with exhaust ventilation. Even with exhaust ventilation, some individuals with asthma and other respiratory diseases can be adversely affected. Electric ranges and ovens combined with exhaust ventilation may be the only option for these individuals. All cook tops and ovens should be installed with range fans that are exhausted to the exterior. In addition, contractors should test new gas appliances for carbon monoxide during installation and prior to use by the occupants.

Gas furnace, gas boiler and gas water heater vent systems should not communicate with occupied spaces. They should always be sealed combustion or power vented devices (see **Figure 39**).

Fireplaces must be vented to the exterior. Never install ventless gas fireplaces. Large exhaust fans (clothes dryer, kitchen range hood) can backdraft fireplaces and wood stoves or induce spillage of smoke and soot into the house. Operating large exhaust fans should be avoided during fireplace and wood stove use.

Fireplaces and other combustion appliances that are not direct-vent sealed combustion should be performance tested annually to ensure the products of combustion are exhausted from the home.

Leaky or disconnected ducts in forced heating and cooling systems can also lead to sufficiently large negative pressures to backdraft and spill fireplaces, wood stoves and other combustion appliances. Using building cavities as returns, such as planned floor joists, should be avoided since they are impossible to seal airtight.

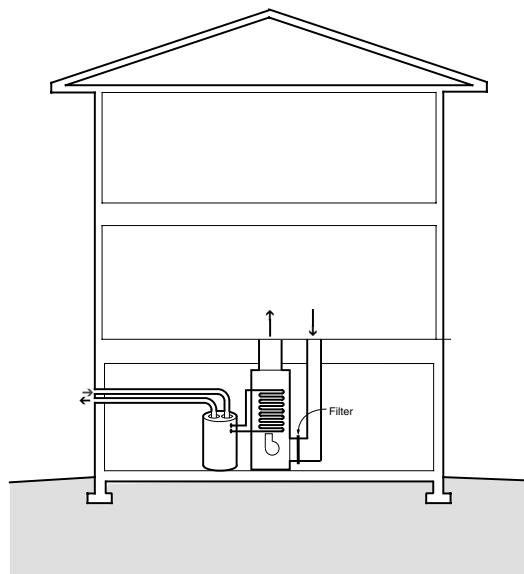

Figure 39
Sealed Combustion Power Vented Gas Water Heater

- Water heater flue gases exhausted to exterior using a fan; combustion air supplied directly to water heater from exterior via duct
- No furnace; heat provided by hot water pumped through a water-to-air heat exchanger (fan-coil)

Garages

Ideally, garages should not be connected to a healthy home. Discrete, separate garages constructed away from homes are preferred. If garages are connected to a home, they should be ventilated to the exterior with a passive vent stack (a “chimney” to the outside — 6-inch duct). Air handling devices such as furnaces or air conditioners should never be located in garages. Nor should forced air ductwork. Weatherstrip the door between the garage and the home and air seal the common wall.

When ductwork passes through a chase or a floor above a garage or adjacent to an exterior wall bordering a garage, it is important that the ductwork be sealed airtight against the migration of pollutants from the garage to inside the home.

Smoke

Smoking should not occur in healthy homes. If you must smoke, smoke outside. Candles and incense produce soot as do fireplaces and wood stoves. Soot can be unhealthy.

Dust

Stop the dust at the door. Vacuum and filter the rest away. And make it easy to clean.

Over two thirds of dust in houses originates outdoors, and is tracked in on feet. House dust is known to contain many hazardous materials. House dust is an asthma trigger.

Entry Control

Pave exterior walks. Use exterior grate track off, interior carpet mat and hard surface floors. Design entries so that there is room to remove and store coats, shoes and boots.

Use a three part track-off approach:

1. Permeable, rugged outdoor mat that collects gritty materials (or a grate over a collection hole is an alternative approach);
2. Rugged indoor mat that collects grit and water and;
3. A hard surface, easily mopped floor to collect very fine particles left by drying foot prints.

Lead Dust Control

Homes built before 1978 may contain lead-based paint. Renovation jobs that cut, saw, demolish or sand paint may create lead hazards. Lead may damage the nervous system causing learning and behavior problems. To minimize the risk of creating dust, follow the steps described in the Lead Paint Safety Field Guide which can be obtained from www.hud.gov/offices/lead. This website also contains information about the Lead-Based Paint Disclosure and Lead-Safe Housing regulations.

Cleanable Surfaces

Whenever possible, replace carpets with smooth flooring which is easy to clean and less likely to retain dust. Use window treatments such as blinds or shades that can be easily wiped. Use hard surfaces rather than textiles. Use semi-gloss latex paints instead of flat or matte finishes. Such surfaces are easier to clean using mild soaps.

Filtration

Construct a tight building enclosure to keep out outside dust and provide filtration. Filters should be MERV 6 – 8 (35 percent or better ASHRAE dust spot efficiency).

Creatures

Infestations of cockroaches, dust mites, mice and rats can all cause allergic reactions. Even after the pests are gone, their skin, hair and feces can remain and can trigger allergic reactions.

Making a home pest-resistant produces a healthier home in two ways: it reduces exposure to allergens and asthma triggers released by the pests, and it can reduce the amount of pesticides used by the occupants.

Design and construct the building so it's easy for people to keep pests from colonizing. Take the following steps:

- Make it hard for them to get in by sealing the walls, ceilings, roofs and foundations
- If they do get in, make it hard for them to move around unseen by sealing passages through interior floors, walls and ceilings, kick spaces
- Make it hard for them to find water by: keeping liquid water out, making plumbing easy to inspect and repair, and insulating plumbing pipes to keep them warm (above dewpoint temperatures)
- Make it hard for them to find food using tight food storage, by keeping paper and wood products away from potential moisture sources, and by using pest-resistant materials
- Make directed use of low toxicity pesticides in locations that are heavily infested with problem creatures.

To Know the Critter is to Control The Critter

To actually do the things on the list, you must know the creature. The simplest, safest and most elegant controls are those that work with the creature's natural urges. Creatures that get eaten a lot don't like open spaces. Give them open spaces. No closed-in kick spaces, strips around buildings free of shrubs and organic mulch. Seal around pipes and wires to keep them out of walls.

Keeping Them Out

Keep them out by changing the surrounding landscape and by blocking pest entries and passages. Reduce food and water availability.

Keep bushes and trees at least 3 feet from homes. Bushes and trees near a home provide food, a living place and sheltered passage for pests such as rats, mice, bats, birds, roaches and ants.

Seal utility openings and joints between materials. Use corrosion-proof materials such as copper or stainless steel mesh. Rodents can chew through many materials and squeeze through tiny openings.

Reducing Food and Water

Provide places to store food that are dry and ventilated. Provide a place to store trash and to facilitate recycling.

Design and construct the home to be dry and to dry if and when it gets wet. Absolutely no installed carpet in areas prone to get wet: bathrooms, laundry rooms, kitchens, entryways and damp basements.

In the Northeast, dust mites do not generally colonize buildings because buildings are too dry for much of the year. They colonize bedding, stuffed animals and favorite chairs because we humidify these things with our bodies. Control is by washing these items in hot water (greater than 130° Fahrenheit), which kills the mites and washes away allergens.

Pesticides

In the design and construction of new buildings, pesticides have a very limited and targeted role to play. In a neighborhood infested with a difficult species, like roaches or termites, use a limited amount of low toxicity pesticide in targeted locations. In high risk termite areas, exclusion and inspection detailing — plus a combination of treated wooden materials and soil treatment — is useful. For roaches, dusting with boric acid in areas that would be hard to treat later is an effective, low risk strategy. For example, dust with boric acid inside the kick space beneath sink, then seal the kick space as completely as possible.

To assess risk factors associated with a pesticide, look at:

- Registration, classification, use, mode of action
- Specificity, effectiveness, repellency
- Toxicity to humans
- Cautions on label
- Toxicity in the environment
- Resistant populations

Look especially for products like insect growth hormone regulators, which are species-specific, effective and have low toxicity for the applicators, occupants and the environment.

Don't spray pesticides; apply them directly to surfaces to be treated.



Building Guidance for Healthy Homes

Developed by The Asthma Regional Council

April 4, 2002

The Asthma Regional Council (ARC) of New England is committed to reducing the impact of asthma on children and families across New England through the collaboration of health, housing, education and environmental organizations. Modifications in current housing construction and maintenance practices can help minimize conditions that are associated with asthma and asthma triggers. This guidance presents the general principles to help achieve healthier indoor environments, recommends specific building practices, and describes technical resources to support the adoption of these healthy building practices.

Background

The number of children diagnosed with asthma has doubled in the past 15 years. Asthma rates in the Northeast are among the highest in the country.

Asthma is an allergic reaction to certain exposures (“triggers”) such as dust, mold, pests (cockroaches, rats, mice), pets (cats and dogs), cold air, and dry heat. Researchers have estimated that over 40% of doctor-diagnosed asthma in children under 16 years of age is associated with residential exposures where these triggers are often present.

This guidance presents principles and specific construction practices designed to minimize residential exposures to asthma triggers. Many of these practices also improve energy efficiency. ARC encourages state housing, finance, environmental and health agencies as well as non-governmental organizations and business involved in developing and maintaining housing to implement these building practices, whenever feasible.

Seven Healthy Homes Principles

Dry: Reducing moisture minimizes mold growth and makes it difficult for pests to thrive.

Clean: Dust can cause allergic reactions that trigger asthma attacks. Clutter and debris make it difficult to remove dust and can be breeding grounds for pests.

Well Ventilated: Ventilation moves air to help reduce excess humidity and airborne contaminants. Spot ventilation exhausts humidity and contaminants from specific sources (bathroom showers, kitchen cooking) minimizing mold. Dilution ventilation deals with low-level contamination throughout the home.

Combustion By-Product Free: Combustion products such as carbon monoxide have adverse health consequences.

Pest Free: Pests can cause allergic reactions that trigger asthma. Pesticides themselves can also create adverse health effects.

Toxic Chemical Free: Containers storing cleaning compounds, pesticides, oil- or alkyd-based paints and solvents can release toxics to the indoor air and exacerbate asthma.

Comfortable: Uncomfortable homes can make people take actions that make a home unhealthy. If people are cold, they won't ventilate their home. If people are dry or hot, they will often open windows and/or add moisture (humidify) to the point of producing mold.

Recommended Building Practices to Achieve Healthier Homes

While there is no recipe that can guarantee a healthy home, the recommended building practices presented here will help create healthier indoor environments. We list the practices under three categories that group the principles. The principle of "comfort" is not a heading as it is inherent in each category

- Dry and Clean;
- Well Ventilated and Free of Combustion Products and Toxics; and
- Pest Free. .

Each home construction and each rehabilitation project presents unique constraints and opportunities. The measures included here were chosen because the opportunities to use

Asthma Regional Council 622 Washington St. 2nd fl Dorchester MA 02124
617.451.0049 x504 Istillman@tmfnet.org www.asthmaregionalcouncil.org

This document was developed by Ellen Tohn, ERT Associates e.tohn@comcast.net

them occur frequently and they are feasible for most construction and rehab projects. These measures may need minor adjustments in specific situations, particularly for projects involving the rehabilitation of existing buildings. Therefore, on-going training in healthy homes principles and access to technical consultations for project designers and builders is critical. Resources for such assistance are described later in this guidance.

An **R** or **C** precedes each practice and denotes whether it is appropriate for renovation and/or new construction. The italicized text explains the rationale for the recommended practice where added description is appropriate.

A reference to the key resource document used to develop these recommendations is provided to give users a citation for additional detail and specifications. The pages referenced in italics are to a pamphlet -- *Healthy and Affordable Housing: Practical Recommendations for Building, Renovating and Maintaining Housing - READ THIS Before You Design, Build or Renovate (READ THIS)*. This is one of a series of three pamphlets developed by Building Science Corporation for training sponsored by the ARC, U.S. Department of Housing and Urban Development, and U.S. Department of Energy's Building America Program. The other two pamphlets provide recommendations "Before You Turn Over a Unit" and "Before You Move In." The pamphlets are available on the Building Science web site www.buildingscience.com and ARC web site www.asthmaregionalcouncil.org. ARC recommends that individuals and organizations consult these pamphlets when developing and revising building standards and practices. The pamphlets include the practices listed here and a broader array of recommendations that will help improve the overall health conditions for occupants.

Dry and Clean Structures

R & C Install pan flashings on all windows and exterior doors. Apply window pan flashings over building paper at sill and corner patches. *Flashing helps direct water away from wall cavities and to the drainage plane.* [READ THIS, Figure 3: Installing window with housewrap on OSB over a wood frame wall, Figure 4: Flashing over and under window trim; pp.12-14]

R & C Avoid putting plumbing in exterior walls. *It is easier to detect and repair leaks in interior walls.* [READ THIS, Figure 17: Locating plumbing pipes, p.22]

R & C Install hot water heaters in rooms with drains or catch pans and floor coverings that are not water sensitive. Install easy to use shut off valves for clothes washers and hot water heaters. *These precautions will minimize damage from leaks.* [READ THIS, p.22]

R & C Use cement board, fiber cement board, or cement plaster as an air barrier in wet areas such as behind tubs or showers. *Do not use paper-faced gypsum board that can wick moisture.* [READ THIS, Figure 26c: Section of tub framing, p.34]

R & C Seal holes to prevent air flow (e.g., utility walls where they intersect exterior walls and ceiling). Seal bathtub and shower enclosures with rigid materials (e.g. sheathing or gypsum board). *This minimizes airflow that can bring in moisture and pests.* [READ THIS, Figures 25: Utility Chase construction, 26: Tub framing, Utility chase construction, 25a, 25b; pp.32-34]

R & C Avoid putting duct work and air handlers in attics because of air leakage. [READ THIS, p.29]

R & C If basement spaces or below grade spaces (garden apartments) are likely to be occupied, they should be designed and constructed for occupancy. They should be dry and have appropriate heating/cooling. Do not use ceiling basement insulation. Instead, insulate basements at their perimeters. Install continuous rigid insulation under concrete floor slabs or above concrete floor slabs coupled with a floating floor. Insulate the wall assemblies in wet areas with semi-vapor permeable foam (e.g., rigid foam). *These strategies will raise the temperature of the floor coverings and below grade walls to control mold and dust mites. Semi-vapor permeable insulation allows the basement wall assemblies to dry to the interior, releases capillary water to the interior in a controlled manner, protects interior finishes, and minimizes the growth of molds* [READ THIS, Figures 8 – 16, 20; pp.17-21, 25, 27]

R & C Insulate cold water pipes. Permeable foam insulation is recommended. *Insulation minimizes condensation in warm temperatures.* [READ THIS, p.36]

R & C Do not install carpet in wet areas (e.g., bathrooms, laundry rooms, kitchens, entryways, and damp basements). Use smooth and cleanable surfaces that do not act as reservoirs for moisture/mold and can be washed (e.g., vinyl, wood, tile, rubber). Whenever possible, install smooth and washable surfaces in other rooms/areas (e.g., common areas, bedrooms, living rooms). *Carpet can trap moisture and dust. They can become a breeding ground for mold; smooth and cleanable surfaces do not trap moisture and are easier to clean.* [READ THIS, p.45]

C Ensure that all exterior claddings have drainage planes between the cladding and the house wrap material. *Drainage planes provide a pathway for water to run away from the structure and avoid creating reservoirs behind cladding.* [READ THIS, Figure 6: Ventilated cavity, Figure 7: Drained cavity with condensing surface, Figure 13: Interior drainage - renovation, pp.15, 20]

C Backprime exterior siding materials (paint back, front, edges and ends of wood siding, cement siding and wood trim). *This helps prevent wood clapboard from absorbing moisture and eliminates a potential water reservoir.* [READ THIS, p.10]

C Install a capillary break on top of the footing between the footing and the perimeter foundation wall. *A break helps minimize movement of moisture from the ground into the building assemblies.* [READ THIS, Figures 8a, 8b, 8c: Groundwater controls, 10:

Asthma Regional Council 622 Washington St. 2nd fl Dorchester MA 02124
617.451.0049 x504 Istillman@tmfnet.org www.asthmaregionalcouncil.org

This document was developed by Ellen Tohn, ERT Associates e.tohn@comcast.net

Capillary rise through basement footing, 11: Capillary break over footing, 12: Capillary control for monolithic slab, pp.17-19]

Well Ventilated and Free of Combustion Products and Toxics

R & C Install exterior exhausting fans in bathrooms and kitchens. Use durable and quiet fans (less than 3 sones). *Fans exhaust excess humidity that can spur mold development.* [READ THIS, Figure 32: Exhaust ventilation system with point source exhaust, p.39]

R & C Install power vented fans or range hoods that exhaust to the exterior when gas cook tops and gas ovens are present. *These fans remove moisture, odors and other contaminants.* [READ THIS, Figure 32: Exhaust ventilation system with point source exhaust, p.39]

R & C Seal forced air ductwork, particularly on the return side (suction side). *This helps avoid negative air pressures that can draw contaminants (radon and soil gas) into homes from below grade or smoke and odors from neighboring units.* [READ THIS, Figure 35; p.41]

C Ventilate attics at the soffits and ridges. [READ THIS, Figure 31: Baffle installation, p.38]

Pest Free

R & C Seal utility openings and joints between openings. Avoid materials that rodents can chew. Use corrosion proof materials (e.g., copper or stainless steel mesh). *Reducing holes minimizes transit pathways for rodents and pests.* [READ THIS, Figure 25: Utility chase construction, p.32]

R & C Seal utility openings and joints between materials. *This minimizes transit pathways for pests.* [READ THIS, p.46]

Training and Technical Assistance

Training and technical assistance are critical to implementing the changes in building practices advocated in this guidance. Housing policy makers, designers, project management staff, and contractors must understand the connections between building construction practices, indoor air quality and asthma and have the practical knowledge to apply healthy home concepts to their own housing projects.

We strongly urge that whenever possible employees involved in designing, constructing, and maintaining publicly funded housing complete relevant training. A list of organizations that provide and/or sponsor such training and technical assistance is provided below.

Asthma Regional Council 622 Washington St. 2nd fl Dorchester MA 02124
617.451.0049 x504 Istillman@tmfnet.org www.asthmaregionalcouncil.org

This document was developed by Ellen Tohn, ERT Associates e.tohn@comcast.net

Government

U.S. Environmental Protection Agency
Office of Air and Radiation
ENERGY STAR Buildings Program & Indoor Environments Division
1200 Pennsylvania Avenue, NW
Washington, DC 20460
888.STAR-YES www.epa.gov/iaq & www.energystar.gov
(publications)

U.S. Department of Housing & Urban Development
Office of Healthy Homes and Lead Hazard Control
451 Seventh Street, SW Room P-3206
Washington, DC 20410
202-755-1785 www.hud.gov/offices/lead
(publications)

U.S. Department of Energy, Building America Program
1000 Independence Ave., SW
Washington, DC 20585
800.dial.DOE www.eren.doe.gov/buildings/building_america
(publications, technical assistance, training)

Non Profit

Affordable Comfort
32 Church Street,
Suite 204
Waynesburg, PA 15370
724-627-5200 <http://www.affordablecomfort.org/home1.html>
(training, conferences, publications)

American Lung Association, Health House® Program
490 Concordia Avenue
St. Paul, MN, 55103-2441
(877) 521-1791, (800) 642-5864 within MN www.healthhouse.org
(publications, training)

Energy & Environmental Building Association
10740 Lyndale Avenue South, Suite 10W
Bloomington, MN 55420-5615
952.881.1098 www.eeba.org
(publications, training, conferences)

Maine Indoor Air Quality Council
PO Box 2438
Augusta, ME 04338-2438
207.626.8115 www.miaqc.org
(publications, training)

Rocky Mountain Institute
1739 Snowmass Creek Road
Snowmass CO 81654-9199
970.927.3851 www.greendesign.net
(publications)

Other Resources

Building Science Corporation
70 Main Street
Westford, MA 01886
978.589.5100 www.buildingscience.com
(publications, training, technical assistance, design)

Terry Brennan, Camroden Associates
724 East Carter Road
Westmoreland, NY 13490
315.336.7955 terry@camroden.com
(training, technical assistance, building diagnostics)

Bill Turner
Turner Building Science, LLC
26 Pinewood Lane
Harrison, Maine 04040-4334
207-583-4571 www.hturner.com
(training, technical assistance, engineering design, building diagnostics)

Technical Resources

*Healthy and Affordable Housing: Practical Recommendations for Building
Renovation and Maintaining Housing:*

- *Before You Design, Build or Renovate*
- *Before You Turn Over a Unit*
- *Before You Move In*

Building Science Inc. developed these three pamphlets for training sponsored by the Asthma Regional Council, US Department of Housing and Urban Development, and US Department of Energy's Building America Program. The pamphlets are available electronically at www.buildingscience.com.

Energy and Environmental Building Association's Builder's Guides (EEBA Guide).
The Department of Energy's Building America Program developed these Guides. Copies are available from Environmental and Energy Building Association, 10740 Lyndale Avenue South, Suite 10W, Minneapolis, MN 55420 952.881.1098 www.eeba.org.



U.S. Department of Energy



Program Partner